

*Granville-Phillips Micro-Ion[®]
Vacuum Measurement System*

Installation, Operation, and Maintenance Instructions

Instruction Manual Catalog No. 358013-07

This manual is for use only with the following catalog numbers:

358501-###-##	358502-###-##	358503-###-##	20358024-T1	358506-T2
358001	358002	358003	358004	358035
358006	358007	20358018	20358023	
20358024	20358028	20358029	20358031	

The “#” symbol represents a variable in the catalog number.

See Section 1.6, Catalog Number Configurations on page 1-12.

For assistance in using or servicing this instrument contact:

Helix Technology Corporation
Colorado Operations
Customer Service Department
6450 Dry Creek Pkwy
Longmont, Colorado 80503-9501 USA
Telephone (303) 652-4400
FAX (303) 652-2844
email: salesco@helixtechnology.com



GRANVILLE-PHILLIPS
HELIX TECHNOLOGY CORPORATION

© Copyright Helix Technology Corporation 1996-2002
All Rights Reserved
Revised: June 2002

Declaration of Conformity

In accordance with ISO/IEC Guide 22 and EN45014

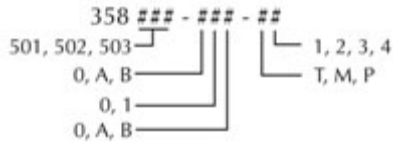
Product Name(s):	Granville - Phillips Series 360/370 Stabil-Ion® Vacuum Gauge Controllers				
Product Number(s):	360101	360102	360187	360188	20360136
	370101	370102	20360150	20360174	20360175
	20360182	20360184	20360185	20370134	20370135
	360###-###-##	370###-###-##	370505-010-T1	370505-A10-T1	
	The “#” symbol represents a variable in the part number. 				
Option(s):					
Conformance to Directive(s):	<input checked="" type="checkbox"/>	EMC Directive 89/336/EEC COUNCIL DIRECTIVE of 03 May 1989 on the approximation of the laws of the Member States relating to electromagnetic compatibility.			
	<input checked="" type="checkbox"/>	Low-Voltage Directive 73/23/EEC COUNCIL DIRECTIVE of 19 February 1973 on the harmonization of the laws of the Member States relating to electrical equipment designed for use within certain voltage limits. Amended by 93/68/EEC.			
Applicable Standard(s):	EMC Directive				
	<input checked="" type="checkbox"/>	EN 50081-2: EMC Generic Emission Standard, Part 2: Industrial Environment, 1994 EN 50082-2: EMC Generic Immunity Standard, Part 2: Industrial Environment, 1995.			
	<input type="checkbox"/>	EN 61326: Electrical Equipment for Measurement, Control and Laboratory Use - EMC Requirements, 1997. Emissions: Class A. Immunity: Annex A - Immunity Test Requirements for Equipment Intended for Use in Industrial Locations.			
	Low-Voltage Directive				
	<input checked="" type="checkbox"/>	EN 61010-1: Safety Requirements for Electrical Equipment for Measurement, Control, and Laboratory Use, Part 1: General Requirements, 1993; A2, 1995.			

The undersigned declares that the products specified above conform to the checked Directive(s) and Standard(s) when installed in accordance with the manufacturer's specifications.

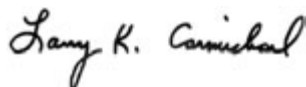

Larry K. Carmichael

Director of Engineering

Date: 08/27/02

Helix Document Number 014119-103

Table of Contents

Safety	v
Safety Instructions	v
Certification	ix
Warranty Information	ix
Service Guidelines	ix
FCC Verification	ix
Chapter 1 System Components	1-1
1.1 System Components	1-1
1.2 Controller Front Panel	1-2
1.2.1 Controls Inside Front Panel	1-3
1.2.2 Top View of Controller (Cover Removed)	1-4
1.3 Options	1-5
1.3.1 Process Control Relay	1-5
1.3.2 RS-232 or RS-485/422 Computer Interface Module	1-5
1.3.2.1 Rear Panel with RS-232 Option	1-5
1.3.2.2 RS-232 Specifications	1-6
1.3.2.3 RS-485 Specifications	1-6
1.3.3 Power On/Off	1-7
1.3.4 Remote Input/Output	1-7
1.3.5 IG Cables	1-7
1.3.6 Mounting Options	1-7
1.4 System Specifications	1-8
1.5 Dimensions	1-10
1.5.1 358 Controller	1-10
1.5.2 Micro-Ion Gauge with Connector	1-11
1.5.3 Convectron Gauge with Connector	1-11
1.5.4 Fittings	1-11
1.6 Catalog Number Configurations	1-12
Chapter 2 Initial Setup Procedures	2-1
2.1 Controller Setup	2-1
2.1.1 Top Cover Removal	2-1
2.2 Pressure Units Setup	2-2
2.2.1 Changing Units of Measure for the Electrometer Module	2-2
2.2.1.1 Overpressure Shutdown Adjustment	2-3
2.2.1.2 Changing the Display Update Rate on Electrometer Module	2-3
2.2.2 Changing Units of Measure for the Convectron Gauge	2-4
2.2.2.1 Display Update Rate Switch on Convectron Module	2-4
2.3 Process Control Setup	2-4
2.3.1 Process Control Channel Identification Windows	2-5
2.3.2 Developing a Logic Diagram of Control Logic	2-5
2.3.3 Ion Gauge Assignment for Process Control	2-7
2.3.4 Relay Polarity Setting	2-8
2.3.5 Process Control Tips	2-9
2.4 RS-232 Computer Interface Setup	2-9
2.4.1 Connector Pinouts for the RS-232 Computer Interface	2-10
2.4.2 Selecting the Byte Format for RS-232 Module	2-10
2.4.2.1 Baud Rate for RS-232 Module	2-10
2.4.2.2 Character Framing for RS-232 Module	2-11
2.4.3 Talk-Only Mode for RS-232 Module	2-11

2.4.4	Handshake Line Control Switches for RS-232 Module	2-12
2.4.5	Invert RTS Switch for RS-232 Module	2-13
2.5	RS-485 Computer Interface Setup	2-14
2.5.1	Connector Pinouts for the RS-485 Computer Interface	2-14
2.5.2	RS-485 Address	2-15
2.5.3	Selecting the Byte Format for RS-485 Module	2-16
2.5.3.1	Baud Rate for RS-485	2-16
2.5.3.2	Character Framing for the RS-485 Computer Interface	2-16
2.5.4	Response Delay for the RS-485 Computer Interface	2-16
2.6	Replacing Controller Cover	2-17
Chapter 3	Installation	3-1
3.1	Gauge Installation Tips	3-1
3.1.1	EMC Compliance	3-1
3.1.2	Cable Installation Statement	3-1
3.1.3	Environmental Conditions	3-2
3.2	Controller Installation	3-2
3.2.1	Installing the Controller	3-2
3.2.2	Installation Hardware Part Numbers	3-2
3.2.3	Mounting Configurations	3-3
3.2.4	Line Voltage	3-4
3.2.4.1	Fuse Replacement Instructions	3-4
3.3	Convectron Gauge Installation	3-5
3.3.1	Mounting Options	3-6
3.3.1.1	Compression Mount/Quick Connect	3-6
3.3.1.2	1/8 NPT Mount	3-6
3.3.1.3	VCR [®] /VCO [®] Mount	3-6
3.3.1.4	NW10KF, NW16KF, NW25KF and NW40KF Flange Mount	3-6
3.3.1.5	ConFlat Flange Mount	3-6
3.4	Grounding the System	3-7
3.4.1	System Ground Test Procedure	3-7
3.4.1.1	Procedure for Testing Grounding of Systems	3-8
3.5	Connecting Analog Outputs	3-9
3.5.1	Electrometer Module Analog Output Signal	3-9
3.5.2	Convectron Gauge Analog Output Signal	3-10
3.6	Connecting Process Control Relays	3-11
3.7	Connecting the RS-232 Computer Interface	3-12
3.7.1	RS-232 Command Summary	3-12
3.7.2	Reversing the Polarity of RTS	3-12
3.8	Connecting the RS-485 Computer Interface	3-13
Chapter 4	Preparing for Operation	4-1
4.1	Preparing for Pressure Measurement	4-1
4.1.1	Alternate ON/OFF Gauge Control	4-2
4.2	Micro-Ion Analog Output Signal	4-2
4.3	Preparing for Convectron Gauge Operation	4-3
4.3.1	Understanding Pressure Measurement in Gases other than Nitrogen (or Air)	4-4
4.3.2	Examples	4-6
4.4	Ionization Gauge Auto Turn On/Off	4-13
4.4.1	Filament Auto Turn-On	4-13
4.5	Adjustment of Convectron Gauge Zero and Atmospheric Pressure Indications	4-14
4.6	Convectron Gauge Analog Output Signal	4-15
4.7	Preparing for Process Control Operation	4-16
4.7.1	Setpoint Display and Adjustment	4-16

4.7.2	Manual Override	4-16
4.7.3	To Display a Setpoint.	4-16
4.7.4	To Modify a Setpoint.	4-17
4.8	Preparing for Use of the RS-232 Computer Interface	4-17
4.8.1	Command Syntax for the RS-232 Computer Interface.	4-17
4.9	Preparing for Use of the RS-485 Computer Interface	4-19
4.9.1	Command Syntax for the RS-485 Computer Interface.	4-20
Chapter 5	Operation	5-1
5.1	Operation of the Series 358 Micro-Ion Vacuum Measurement System	5-1
5.1.1	Turning On the Controller.	5-1
5.1.2	Micro-Ion Gauge On/Off.	5-3
5.1.3	Degas On/Off	5-3
5.1.4	Special Considerations for Convectron Gauge Use Below 10^{-3} Torr	5-3
5.2	Operation of Micro-Ion Gauge Electrometer Module	5-4
5.2.1	Displaying Sensitivity with the Calibration Switch	5-4
5.2.2	Emission Range Switch.	5-4
5.2.3	Sensitivity Adjustment	5-4
5.2.3.1	Relative Gas Sensitivities	5-4
5.2.4	Filament Selection for the Micro-Ion Gauge Electrometer Module	5-5
5.2.4.1	Filament Select Switch	5-5
5.3	Theory of Operation	5-6
5.3.1	Micro-Ion Gauge Theory of Operation	5-6
5.3.2	Convectron Gauge Theory of Operation	5-7
5.3.3	Microcontrollers and Bus Structure	5-7
5.3.4	Process Control Theory of Operation.	5-8
5.3.4.1	Process Control Specifications	5-8
Chapter 6	Service and Maintenance	6-1
6.1	Service Guidelines	6-1
6.2	Damage Requiring Service	6-2
6.3	Overpressure Shutdown	6-4
6.4	Troubleshooting the Convectron Gauge Module	6-5
6.4.1	Convectron Gauge Test Procedure	6-5
6.4.2	Cleaning Contaminated Convectron Gauges	6-6
6.5	Process Control Troubleshooting	6-6
6.6	RS-232 Troubleshooting	6-7
6.7	RS-485 Troubleshooting	6-8
6.8	Field Installation of Modules	6-9
6.9	Service Form	6-10
Index	Index-1

Safety Instructions

START BY READING THESE IMPORTANT SAFETY INSTRUCTIONS AND NOTES collected here for your convenience and repeated with additional information at appropriate points in these instructions.

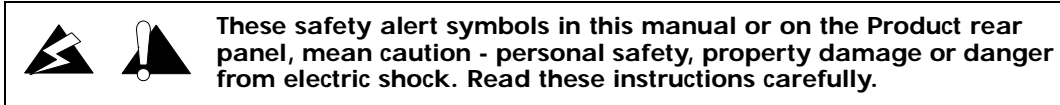

In these instructions the word “product” refers to the Series 358 Micro-Ion Vacuum Measurement System and all of its approved parts and accessories.

NOTE: These instructions do not and cannot provide for every contingency that may arise in connection with the installation, operation, or maintenance of this product. Should you require further assistance, please contact Helix Technology at the address on the title page of this manual.

This product has been designed and tested to offer reasonably safe service provided it is installed, operated, and serviced in strict accordance with these safety instructions.

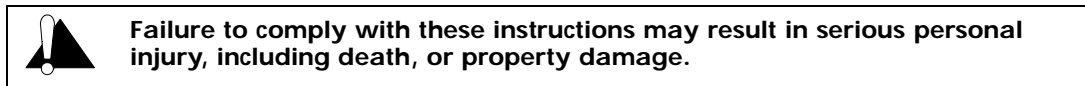

These safety precautions must be observed during all phases of operation, installation, and service of this product. Failure to comply with these precautions or with specific warnings elsewhere in this manual violates safety standards of design, manufacture, and intended use of the instrument. Helix Technology disclaims all liability for the customer's failure to comply with these requirements.

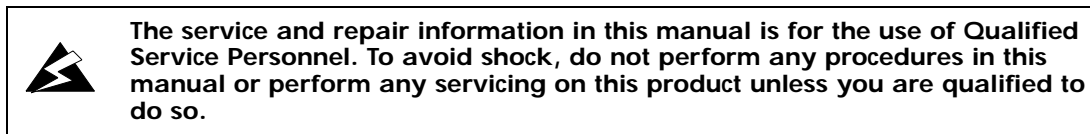

- *Read Instructions* – Read all safety and operating instructions before operating the product.
- *Retain Instructions* – Retain the Safety and Operating Instructions for future reference.
- *Heed Warnings* – Adhere to all warnings on the product and in the operating instructions.
- *Follow Instructions* – Follow all operating and maintenance instructions.
- *Accessories* – *Do not* use accessories not recommended in this manual as they may be hazardous.

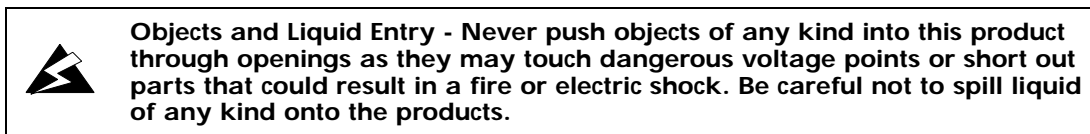
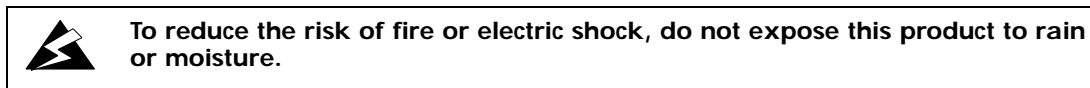

Do not substitute parts or modify instrument.



Because of the danger of introducing additional hazards, do not install substitute parts or perform any unauthorized modification to the product. Return the product to a service facility designated by Helix Technology for service and repair to ensure that safety features are maintained. Do not use this product if it has unauthorized modifications.

Damage Requiring Service

Disconnect the product from the wall outlet and all power sources and refer servicing to Qualified Service Personnel under the following conditions:

- a. When any cable or plug is damaged.
- b. If any liquid has been spilled onto, or objects have fallen into, the product.
- c. If the product has been exposed to rain or water.
- d. If the product does not operate normally even if you follow the operating instructions. Adjust only those controls that are covered by the operation instructions. Improper adjustment of other controls may result in damage and will often require extensive work by a qualified technician to restore the product to its normal operation.
- e. If the product has been dropped or the enclosure has been damaged.
- f. When the product exhibits a distinct change in performance. This indicates a need for service.



Replacement Parts - When replacement parts are required, be certain to use the replacement parts that are specified by Helix Technology, or that have the same characteristics as the original parts. Unauthorized substitutions may result in fire, electric shock or other hazards.



Safety Check - Upon completion of any service or repairs to this product, ask the Qualified Service Person to perform safety checks to determine that the product is in safe operating order.



Finite Lifetime - After ten years of normal use or even non-use, the electrical insulation in this product may become less effective at preventing electrical shock. Under certain environmental conditions which are beyond the manufacturer's control, some insulation material may deteriorate sooner. Therefore, periodically inspect all electrical insulation for cracks, crazing, or other signs of deterioration. Do not use if the electrical insulation has become unsafe.



Be aware that when high voltage is present in any vacuum system, a life threatening electrical shock hazard may exist unless all exposed conductors are maintained at earth ground.

This hazard is not peculiar to this product.



Be aware that an electrical discharge through a gas may couple dangerous high voltage directly to an ungrounded conductor almost as effectively as would a copper wire connection. A person may be seriously injured or even killed by merely touching an exposed ungrounded conductor at high potential.

This hazard is not unique to this product.

Proper Grounding:

All components of a vacuum system used with this or any similar high voltage product must be maintained at earth ground for safe operation. The power cord of this product shall be connected only to a properly grounded outlet. Be aware, however, that grounding this product does not guarantee that other components of the vacuum system are maintained at earth ground.



Complying with the usual warning to connect the power cable only to a properly grounded outlet is necessary but not sufficient for safe operation of a vacuum system with this or any similar high voltage producing product.

Verify that the vacuum port to which the 358 Gauge is mounted is electrically grounded. It is essential for personnel safety as well as proper operation that the envelope of the gauge be connected to a facility ground. Use a ground lug on a flange bolt if necessary.



All conductors in, on, or around the vacuum system that are exposed to potential high voltage electrical discharges must either be shielded at all times to protect personnel or must be connected to earth ground at all times.



Danger, High Voltage – The high voltages present within the Power Supply are capable of causing injury or death. To avoid electric shock, wait 3 minutes after power is removed before touching any component within the Power Supply. This will permit charged capacitors to discharge.



Danger, high voltage – 180V is present in the Power Supply, on the cable, and at the ion gauge when the gauge is turned on. Voltages as high as 850V peak are present during degas.



Do not touch the 358 Gauge during degas operation if the Guard has been removed. Serious burns can occur.













Install suitable devices that will limit the pressure to the level that the vacuum system can safely withstand. In addition, install suitable pressure relief valves or rupture disks that will release pressure at a level considerably below the pressure that the system can safely withstand.

Suppliers of pressure relief valves and pressure relief disks are listed in the *Thomas Register* under “Valves, Relief”, and “Discs, Rupture”.

Confirm that these safety devices are properly installed before installing the product. In addition, check that:

- (1) the proper gas cylinders are installed,
- (2) gas cylinder valve positions are correct on manual systems, and
- (3) the automation is correct on automated gas delivery systems.

Vacuum gauges with compression fittings may be forcefully ejected if the vacuum system is pressurized.

-  Do not operate in an explosive atmosphere.
Do not operate the product in the presence of flammable gases or fumes. Operation of any electrical instrument in such an environment constitutes a definite safety hazard.
-  Do not use the product to measure the pressure of explosive or combustible gases or gas mixtures. The sensor wire of the Convector Gauge normally operates at only 125 °C, but it is possible that Controller malfunction can raise the sensor temperature above the ignition temperature of combustible mixtures.
- Danger of explosion or inadvertent venting to atmosphere exists on all vacuum systems which incorporate gas sources or involve processes capable of pressurizing the system above safe limits.
-
-  **Warning** - If used improperly, Convector Gauges can supply misleading pressure indications that can result in dangerous overpressure conditions within the system. For use with gases other than air or N₂, consult the gas type correction charts in Section 4.3.1 on page 4-4.
-
-  Using the N₂ calibration to pressurize a vacuum system above about 1 Torr with certain other gases can cause dangerously high pressures which may cause explosion of the system. See Section 4.3.1 on page 4-4 before using with other gases.
-
-  **Caution:** If the overpressure shutdown point is increased from the factory settings, an excess pressure rise may go undetected—resulting in possible gauge and/or vacuum system damage. Consult the factory if in doubt.
-
-  It is the installer's responsibility to ensure that the automatic signals provided by the product are always used in a safe manner. Carefully check the system programming before switching to automatic operation.
-
-  Where an equipment malfunction could cause a hazardous situation, always provide for fail-safe operation. As an example, in an automatic backfill operation where a malfunction might cause high internal pressures, provide an appropriate pressure relief device.
-
-  Do not disconnect the ionization gauge cable from either the gauge tube or Controller when the ion gauge is on. The connectors are not rated to break the currents and voltages delivered to the ion gauge.
-
-  Operation of the product with line voltage other than that selected by the proper power supply switches can cause damage to the instrument and injury to personnel.
-
-  The fumes from solvents such as trichloroethylene, perchloroethylene, toluene, and acetone can be dangerous to health if inhaled. Use only in well ventilated areas exhausted to the outdoors. Acetone and toluene are highly flammable and should not be used near an open flame or energized electrical equipment.
-
-  Gauges with tungsten filaments should not be operated above 5×10^{-3} Torr in air for optimum filament life.

Certification

Helix Technology certifies that this product met its published specifications at the time of shipment from the factory. Helix Technology further certifies that its calibration measurements are traceable to the National Institute of Standards and Technology to the extent allowed by the Institute's calibration facility. See also **CE** Declaration of Conformity inside envelope for **CE** tests performed.

Warranty Information

Helix Technology Corporation provides an eighteen (18) month warranty from the date of shipment for new Granville-Phillips Products. The Helix Technology Corporation General Terms and Conditions of Sale provides the complete and exclusive warranty for Helix Technology Corporation's products. This document is located on our web site at www.helixtechnology.com, or may be obtained by contacting Helix Technology Corporation's Customer Service Representative.

Service Guidelines

Some minor problems are readily corrected on site. If the product requires service, please contact our Customer Service Department at 1-303-652-4400 for troubleshooting help over the phone. If the product must be returned for service, request a Return Authorization (RA) from Helix Technology (see the Service Form on page 6-10). Do not return products without first obtaining an RA.

Shipping damage on returned products as a result of inadequate packaging is the Buyer's responsibility.

When returning equipment to Helix Technology, please use the original packing material whenever possible. Otherwise, contact your shipper or Helix Technology for safe packaging guidelines. Circuit boards and modules separated from the Controller chassis must be handled using proper anti-static protection methods and must be packaged in anti-static packaging. Helix Technology will supply return packaging materials at no charge upon request.

FCC Verification

This equipment has been tested and found to comply with the limits for a Class A digital device, pursuant to Part 15 of the FCC Rules. These limits are designed to provide reasonable protection against harmful interference when the equipment is operated in a commercial environment. This equipment generates, uses, and can radiate radio frequency energy and, if not installed and used in accordance with this instruction manual, may cause harmful interference to radio communications. However, there is no guarantee that interference will not occur in a particular installation. Operation of this equipment in a residential area is likely to cause harmful interference in which case the user will be required to correct the interference at his own expense. If this equipment does cause harmful interference to radio or television reception, which can be determined by turning the equipment off and on, the user is encouraged to try to correct the interference by one or more of the following measures:

- Reorient or relocate the receiving antenna.
- Increase the separation between the equipment and the receiver.
- Connect the equipment into an outlet on a circuit different from that to which the receiver is connected.
- Consult the dealer or an experienced radio or television technician for help.

Canadian Users

This Class B digital apparatus meets all requirements of the Canadian Interference-Causing Equipment Regulations.

Cet appareil numérique de la classe B respecte toutes les exigences du Règlement sur le matériel brouilleur du Canada.

NOTES

System Components

The Series 358 Micro-Ion Vacuum Measurement System can operate one Micro-Ion Gauge along with two Convectron Gauges simultaneously.

Pressure readout is via three front panel displays, analog output, and available computer interface.

The Series 358 Micro-Ion Vacuum Measurement System is a modular instrument that can be easily customized to fit most user's exact needs. Infrequently used controls are housed behind a hinged front panel, reducing front panel clutter and allowing the Controller to reside in a half-rack space.

1.1 System Components



Figure 1-1 Series 358 Micro-Ion Vacuum Measurement System.

1. 358 Controller
2. Micro-Ion Gauge
3. Convectron Gauges

1.2 Controller Front Panel

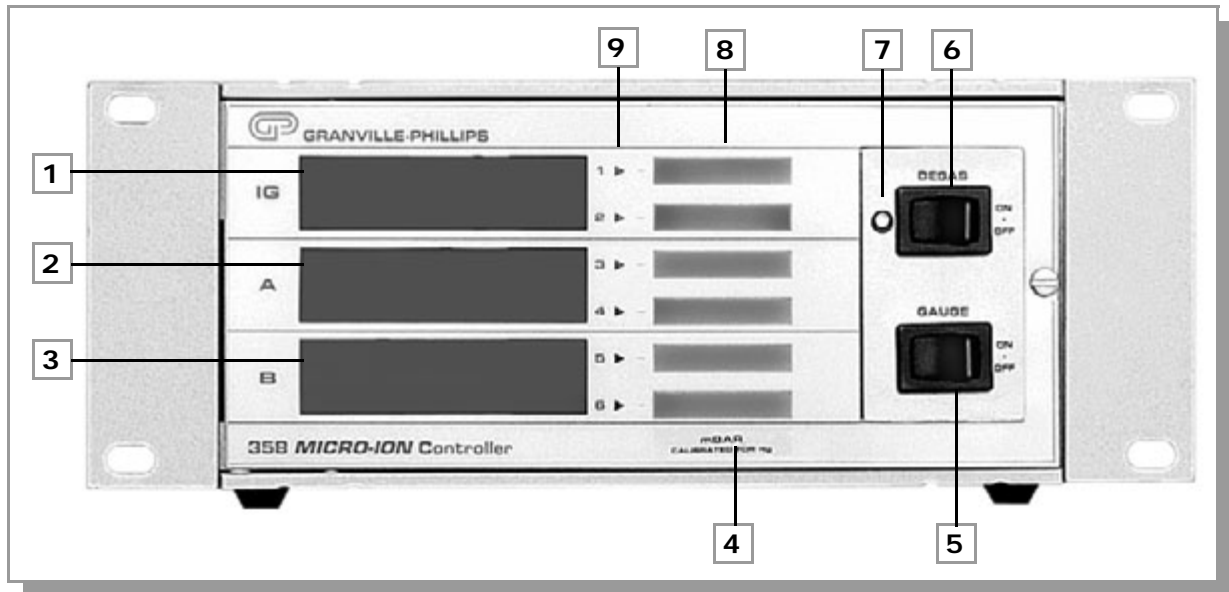

Figure 1-2 358 Controller Front Panel.

- | | |
|---|---|
| 1. Micro-Ion display | 6. Degas “momentary” On/Off switch |
| 2. Convectron Gauge A display | 7. Degas LED |
| 3. Convectron Gauge B display | 8. Process Control channel labels |
| 4. Unit of measure label, Torr, mbar or Pascal, user selectable | 9. Process Control channel indicator lights |
| 5. Micro-Ion Gauge “momentary” On/Off switch | |

1.2.1 Controls Inside Front Panel

Open the front panel door to access these controls.

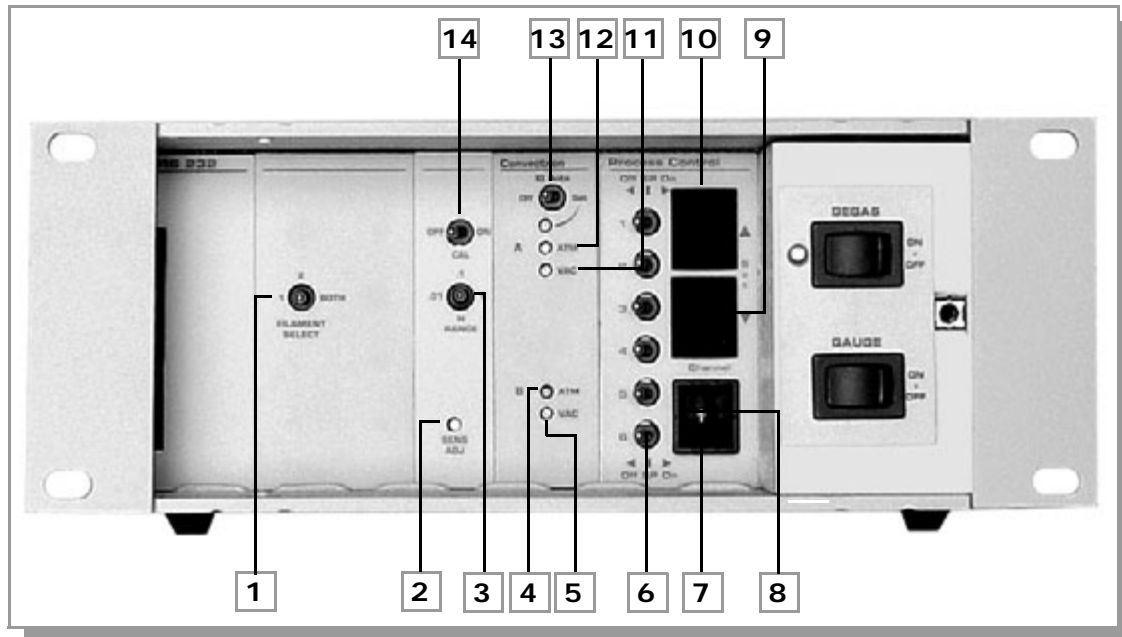

Figure 1-3 358 Controller Front Panel (door open).

1. Filament select switch: Filament 1, Filament 2, or both
2. Sensor adjustment
3. Pressure range selector
4. Atmosphere adjustment, Convectron Gauge B
5. Vacuum zero adjustment, Convectron Gauge B
6. Process Control setpoint three-position manual override switches.
Center = relay is controlled automatically.
Left = relay is de-activated.
Right = relay is activated.
7. Process Control channel indicator
8. Process Control channel selector thumbwheel
9. "Down" Process Control setpoint pressure Set pushbutton
10. "Up" Process Control setpoint pressure Set pushbutton
11. Vacuum zero adjustment, Convectron Gauge A
12. Atmosphere adjustment, Convectron Gauge A
13. IG Auto ON switch, Convectron Gauge
14. Calibration ON Switch

1.2.2 Top View of Controller (Cover Removed)

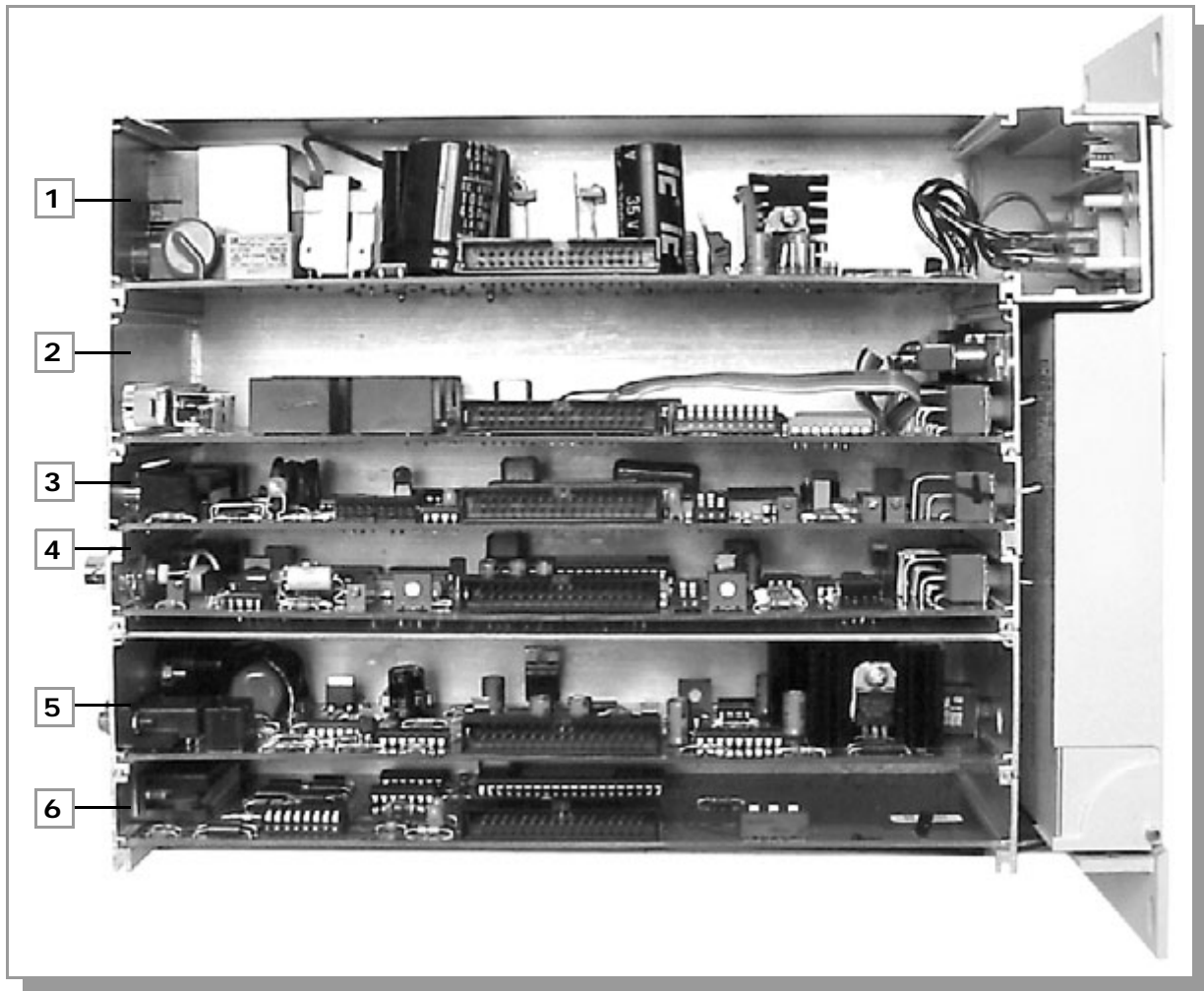

Figure 1-4 358 Controller Top View (cover removed).

1. Power supply board
2. Process Control board
3. Convector board
4. Electrometer board
5. Filament/Grid Supply board
6. RS-232 board

1.3 Options

1.3.1 Process Control Relay

A 2, 6 or 1-4 channel process control relay option can either be factory installed or added at any time by the user. The set points are adjustable from atmosphere to 1×10^{-10} Torr with override switches and front panel status indication.

1.3.2 RS-232 or RS-485/422 Computer Interface Module

Provides readout of pressure, process control relay status, and Micro-Ion Gauge control.

1.3.2.1 Rear Panel with RS-232 Option

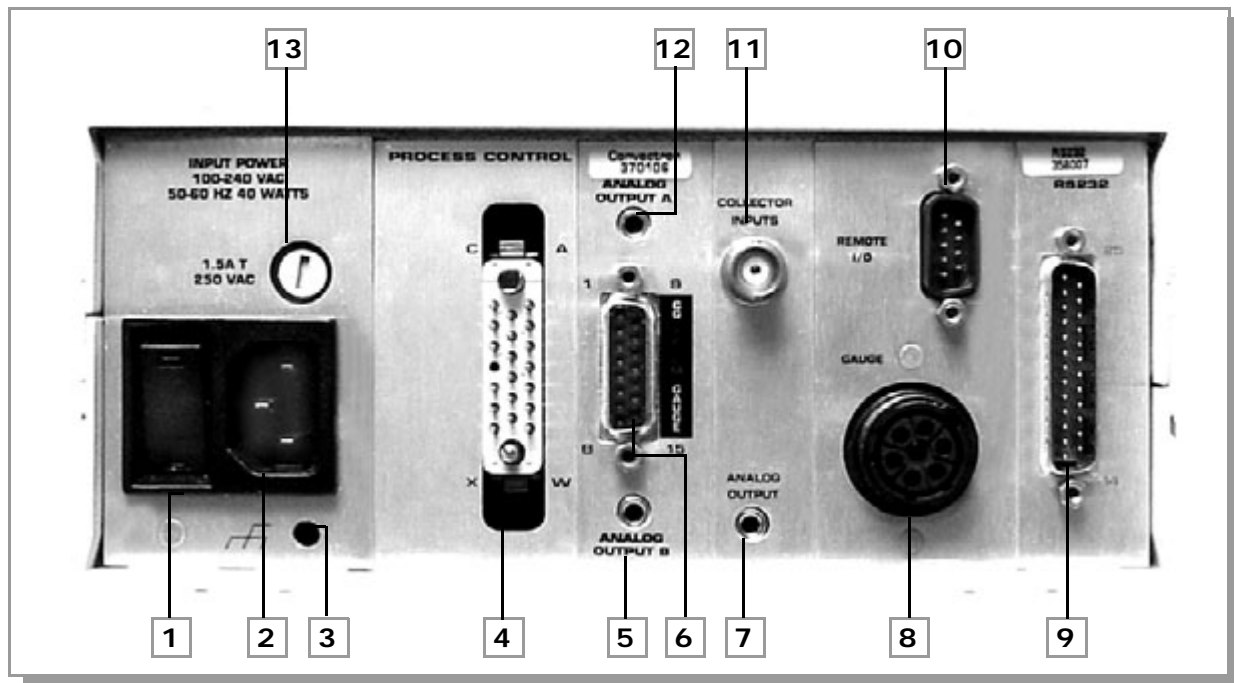

Figure 1-5 358 Controller Rear Panel (with RS-232 Option).

- | | |
|---|---|
| 1. Power switch | 8. Micro-Ion Gauge |
| 2. Power input connector | 9. DB25S connector for RS-232 computer interface |
| 3. Grounding lug to be connected to earth ground with #12 AWG conductor | 10. DE9S connector for remote parameter selection inputs |
| 4. 20-pin connector for Process Control relay contacts | 11. Collector connector for Micro-Ion Gauge |
| 5. Connector for analog output voltage from Convectron Gauge B | 12. Connector for analog output voltage from Convectron Gauge A |
| 6. DA15P connector for Dual Convectron Gauge Cable | 13. Fuse holder |
| 7. Connector for analog output voltage from Micro-Ion Gauge | |

1.3.2.2 RS-232 Specifications

Table 1-1 RS-232 Specifications.

Item	Specification
Format	EIA standard RS-232-C, half duplex, asynchronous.
Data Rates	75,150,300,600,1200,2400,4800,9600 baud.
Character length	7 or 8 bit ASCII, switch selectable.
Parity	Odd, even, or none, switch selectable.
Stop bits	1 or 2. 8 character bits plus parity allows only 1 stop bit.
Handshake	Outputs: DTR,RTS. RTS polarity selectable. Inputs: DSR, CTS, DCD. May be forced to logic "TRUE" with switches.
Logic levels	Inputs: Logic 1, 2.0 Vdc min.,15 Vdc max. Logic 0, -15 Vdc min., 0.75 Vdc max. Input Current: 4.0 mA max @ Vin = +15 Vdc. -4.0 mA max @ Vin = -15 Vdc.

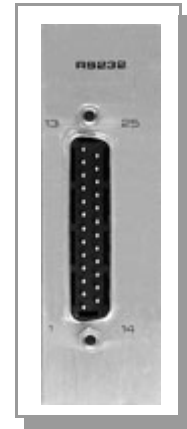
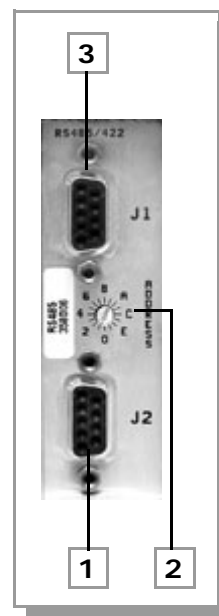

Figure 1-6 RS-232 Option.

1.3.2.3 RS-485 Specifications

Table 1-2 RS-485 Specifications.

Item	Specification
Format	Half duplex, asynchronous.
Data Rates	19200, 9600, 4800, 2400, 1200, 600, 300, 150 baud.
Character length	8 bit or 7 bit ASCII.
Parity	No parity, even, or odd.
Stop bits	1 or 2.
Handshake	None.
Address	256 selectable combinations.
Number of connections	Up to 32 devices.
Total cable length	4000 ft. maximum.



1. J 2 DE9P
Connector for
RS-485/422
computer interface
2. Address dial
3. J 1 DE9P
Connector for
RS-485/422
computer interface

Figure 1-7 RS-485/422 Option.

1.3.3 Power On/Off

To turn on the Series 358 Micro-Ion Vacuum Measurement System depress the top half of the power switch located on the rear panel of the Controller (see Figure 1-5 on page 1-5).

1.3.4 Remote Input/Output

Two TTL compatible inputs are provided through the rear panel allowing control of the Micro-Ion Gauge and degas. The function of the front panel keys is reproduced by either a contact closure or an asserted low (0V) logic state on these inputs. This low state must be held continuously for at least 25 milliseconds. After this, the input must be allowed to pull high for at least 105 milliseconds before another low will be accepted. These inputs have passive pull-ups.

A single-pole, double-throw relay is provided to indicate Micro-Ion Gauge status (normally open contact is open when the Micro-Ion Gauge is off).

Table 1-3 Remote Input/Output Pin Functions.

Pin No.	Function	Pin No.	Function
1	Gauge On/Off Remote*	6	Degas On/Off Remote*
2	Ground	7	Ground
3	Not Used	8	Not Used
4	Gauge Status Common	9	Gauge Status N.O. (Normally Open)
5	Gauge Status N.C. (Normally Closed)		

*Active Low Inputs

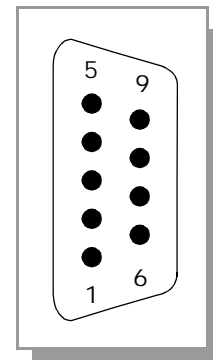

Figure 1-8 Remote Input/Output Connector.

1.3.5 IG Cables

The Series 358 Micro-Ion Vacuum Measurement System is capable of operating an Micro-Ion Gauge located up to 50 feet away from the Controller by using standard cables.

1.3.6 Mounting Options

The Series 358 Micro-Ion Vacuum Measurement System can be ordered with a variety of mounting options to fit your needs. This includes half rack (standard), full rack, or two units in a full rack. (See Section 3.2.3 Mounting Configurations on page 3-3.)

1.4 System Specifications

Table 1-4 Specifications for the Series 358 Micro-Ion Vacuum Measurement System.

Micro-Ion System	
Pressure Range for N ₂ /Air*	
Lower Measurement Limit	<1 x 10 ⁻⁹ Torr (1.3 x 10 ⁻⁹ mbar) (1 x 10 ⁻⁷ Pa)
Upper Measurement Limit	Atmosphere
358 Controller	
Electronic Accuracy	Typical ± 3% of reading at ambient temperature of 25 ± 5 °C.
Display	Digital, green LED, 2 digits plus exponent
Units	Torr, mbar, pascal (user selectable)
Update Rate	0.5 sec. typical as shipped. Internal switch selectable to 3 sec./reading averaged.
Filament Control	Switch-selectable: filament 1, filament 2, or both
Degas	Electron bombardment, approximately 4 W with 2 minute timer
Maximum Ionization Gauge Cable Length	15 m (50 ft) with standard cable
Remote I/O	IG status relay rated at 1.0 A, 30 Vdc. Momentary ground controls filament selection and degas.
Gauge and Degas On/Off Inputs	Less than 0.4 Vdc @ 10 µA for 25 msec (min.). Must go to greater than 3.5 Vdc for 105 msec (min.) before next low state.
Filament Status Relay Contact Rating	1.0 Adc, 30 Vdc
Environment	Indoor use Altitude up to 2000 meters Temperature 0 °C to 40 °C Maximum relative humidity 80% for temperatures up to 31 °C decreasing linearly to 50% relative humidity at 40 °C Transient overvoltages according to installation category (overvoltage category) II Pollution degree 2 in accordance with IEC 664
Operating Temperature	0 °C to +40 °C ambient, noncondensing
Non-operating Temperature	-40 °C to +70 °C
Analog Output	0 to 10 Vdc, logarithmic, 1 V/decade
Overpressure Protection	Gauge turns off if pressure rises above factory set upper pressure limit
Emission Current Settings	0.02 mA (MV), 1 mA (HV), 4 mA (UHV)
Operating Voltage & Power	100 to 240 Vac, 50 to 60 Hz, 50 W maximum, ±10%
Fuse Rating	250 V, 1.6 A, 5 x 20mm Time Lag (T), low breaking capacity
Weight	1.8 kg (4 lb)

* Measurement limits are determined by the Controller emission current setting and x-ray limit of the gauge.

Controller Options	
Process Control	
Relay Configuration	SPDT, Form C
Contact Rating	5A @ 120 Vac, 4A @ 240 Vac resistive or 5A @ 30 Vdc
Channels	6 maximum, 2 per operating gauge maximum
Hysteresis	10%
Setpoint Adjustment	Digital, 2 significant digits plus exponent
Digital Interfaces	RS-232 or RS-485/422
Dual Convectron Gauge	
Pressure Range	999 to 1×10^{-4} Torr for N ₂ /Air
Display Units	Torr, mbar, pascal (user selectable)
Maximum Cable Length	150 m (500 ft)
Analog Output	0 to 7 V, logarithmic, 1 V/decade, adjustable offset of +1 to -7 V
Display Resolution	2 significant digits, except for lowest two decades

Micro-Ion Gauge	
Sensitivity	3/Torr to 50/ Torr (factory setting is 20/Torr)
Emission Current	20 μ A, 1 mA, 4 mA
Collector Potential	0 V
Grid Potential	+180 Vdc
Filament Potential	+30 Vdc
Degas	Electron bombardment: 15 mAdc, 250 Vdc, auto turn-off, 2 minutes
Analog Output	0 – 10 Vdc, logarithmic, 1 V/decade
Filaments	Dual yttria-coated iridium, or tungsten [†]
Operating Temperature	0 °C to +50 °C ambient, noncondensing
Bakeout Temperature	+200 °C maximum
Cable Bakeout Temperature	+150 °C maximum
Materials Exposed to Vacuum	Vacuum fired, UHV compatible
Internal Volume	10.8 cm ³ (0.66 in. ³)
Weight	0.1 kg (4 oz.) (with 1 5/16 in. Conflat [®] type flange)

[†] Tungsten filaments are for applications involving gases containing fluorine, chlorine, or other gas species that poison yttria-coated iridium filaments. Tungsten filaments are not recommended for general vacuum applications because they may burn-out when exposed to high pressures.

Ion Gauge Pressure Range*			
Pressure Range Designation	MV (medium vacuum)	HV (high vacuum)	UHV (ultrahigh vacuum)
Emission Current	20 μ A	1 mA	4 mA
Recommended Upper Limit, Torr	5×10^{-2}	8×10^{-4}	2×10^{-4}
Recommended Lower Limit, Torr	1×10^{-6}	1×10^{-7}	less than 1×10^{-9}

* Internal overpressure limiter is factory-adjusted to trip at the upper limits specified above.

Convectron Gauge	
Pressure Range	1×10^{-4} Torr to 990 Torr, N ₂ equivalent
Display Resolution	2 significant digits, except for 1 significant digit in 10^{-4} Torr decade
Gas Type	N ₂ , air (for direct reading)
Display Update Time	0.5 sec. typical. Switch selectable to 3 sec./reading, averaged.
Analog Output	0 – 7 Vdc, logarithmic, 1 V/decade.
Ion Gauge Turn-On Range	Less than or equal to 100 mTorr
Sensor Material	Gold-plated tungsten
Mounting Orientation	Gauge axis must be horizontal to provide accurate measurement above about 1 Torr
Operating Temperature	+4 °C to +50 °C ambient, noncondensing
Bakeout Temperature	+150 °C maximum, nonoperating, cable disconnected
Cable Bakeout Temperature	+105 °C maximum

1.5 Dimensions

1.5.1 358 Controller

The dimensions of the 358 Controller in a half-rack (standard) mounting are shown in Figure 1-9.

Dimensions are in cm (in.).

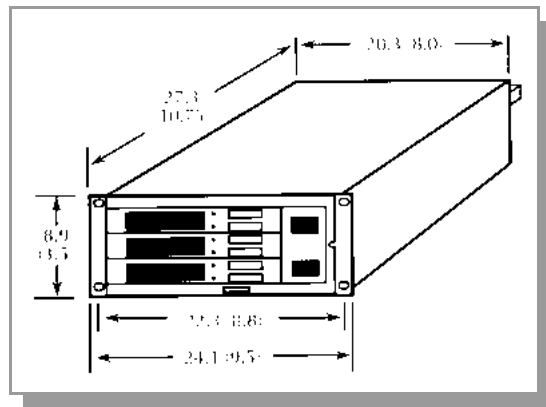

Figure 1-9 358 Controller Dimensions.

1.5.2 Micro-Ion Gauge with Connector

The dimensions of the Micro-Ion Gauge are shown in Figure 1-10.

Dimensions are in cm (in.).

H dimensions are given in Table 1-5.

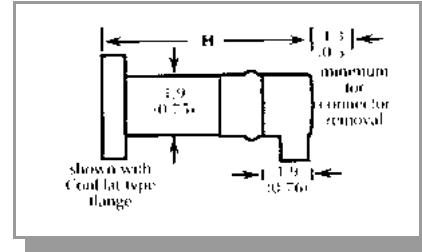

Figure 1-10 Micro-Ion Gauge Dimensions.

1.5.3 Convecatron Gauge with Connector

The dimensions of the Convecatron Gauge are shown in Figure 1-11.

Dimensions are in cm (in.).

J dimensions are given in Table 1-5.

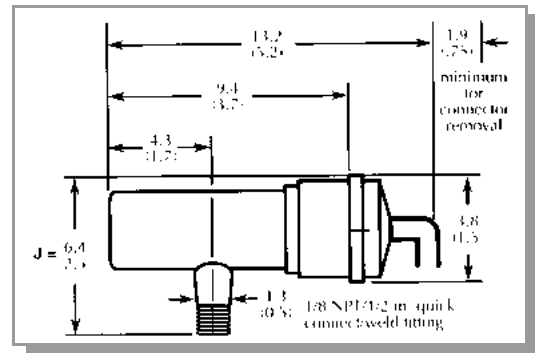





Figure 1-11 Convecatron Gauge Dimensions.

1.5.4 Fittings

Table 1-5 Fittings for Both Micro-Ion and Convecatron Gauges.

Fitting	Description	Dimension H	Dimension J
	0.75 inch port diameter 1.0 inch port diameter 15 mm port diameter 18 mm port diameter	9.4 cm (3.7 in.) 9.4 cm (3.7 in.) 9.4 cm (3.7 in.) 9.4 cm (3.7 in.)	N.A. N.A. N.A. N.A.
	1/4 inch VCR-type 1/2 inch VCR-type	N.A. 8.6 cm (3.4 in.)	8.1 cm (3.2 in.) 7.9 cm (3.1 in.)
	NW16KF flange NW25KF flange NW40KF flange	7.3 cm (2.9 in.) 7.3 cm (2.9 in.) 7.3 cm (2.9 in.)	6.9 cm (2.7 in.) 6.9 cm (2.7 in.) N.A.
	1.33 inch ConFlat-type 2.75 inch ConFlat-type	7.3 cm (2.9 in.) 7.3 cm (2.9 in.)	6.4 cm (2.5 in.) 6.4 cm (2.5 in.)

VCR is a registered trademark of Cajon Co.; ConFlat of Varian Associates.

1.6 Catalog Number Configurations

Series 358 Micro-Ion Gauge Controller with 3-line display (CE-Marked)

Choose one of the basic controllers and add the options below to create your catalog number.

Controller with half-rack mount brackets	358501 - # # # - # #
Controller with left mount for 19-inch rack	358502 - # # # - # #
Controller with center mount for 19-inch rack	358503 - # # # - # #

Interface Options (Slot X):

None	0
RS-232	A
RS-485/422	B

Gauge Options (Slot Y):

None	0
Dual Convectron	1

Setpoint Options (Slot Z):

None	0
2 setpoint relays for Micro-Ion Gauge	A
6 setpoint relays, 2 per channel	B

Display Options - Measurement units:

Torr	T
mbar	M
Pa	P

Power Cord Options:

North America 115 V	1
North America 240 V	2
Universal Europe 240 V	3
United Kingdom 240 V	4

Example: To order a Series 358 Micro-Ion Gauge Controller with half-rack mount, RS-485 interface, dual Convectron Gauge operation, 6 setpoint relays, display in Torr, and North America 115 V power cord, select catalog number: 3585018-B2B-T1.

Initial Setup Procedures

2.1 Controller Setup

Now is a convenient time to make any required switch changes before mounting the Controller in its desired location.

If the pressure display units of measure are correct (see Figure 2-1), and you do not wish to change the degas power timer from the factory setting of 10 minutes, skip to Chapter 3 Installation.

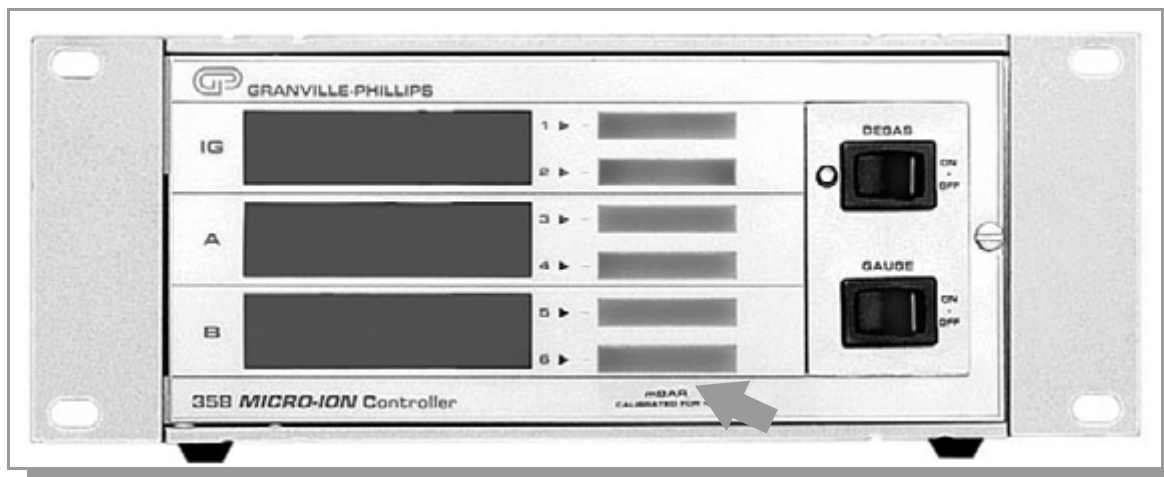

Figure 2-1 Controller Front Panel Showing Location of Units of Measure Label.

If you want to change the units of measure or the display rate, you must remove the top cover of the Controller.

2.1.1 Top Cover Removal

1. With power off, remove any cables from Controller rear panel.
2. Observe antistatic precautions to avoid damaging static sensitive components inside the chassis. Use a grounded, conductive work surface. Do not handle integrated circuits (IC) devices more than necessary, and only when wearing a high impedance ground strap. (A high impedance helps protect human life in case of inadvertent contact with high voltage.)

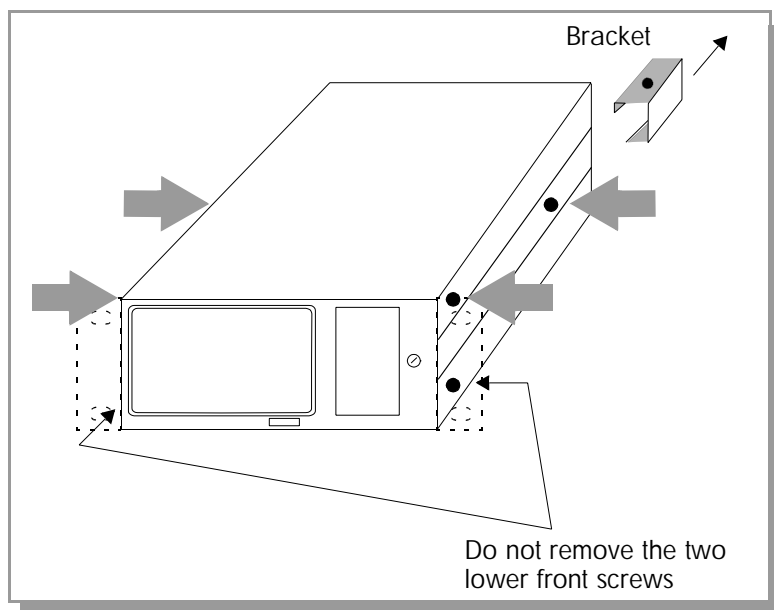

Figure 2-2 Location of Screws for Removal of Top Cover.

- Remove the four Phillips head screws identified in Figure 2-2. If the unit is equipped with a rear bracket instead of one rear screw, unfasten the Phillips head screw on the bracket, and slide off the bracket.

2.2 Pressure Units Setup

If units of measure are as desired (see Figure 2-1 on page 2-1), skip to Section 2.2.1.2 Changing the Display Update Rate on Electrometer Module on page 2-3.

2.2.1 Changing Units of Measure for the Electrometer Module

Your unit will have been shipped from the factory pre-set to display the unit of measure, Torr, millibar, or Pascal, that you requested. Selection between Torr and mbar units is done by adjusting the IG tube sensitivity to the appropriate units. For example, a tube has a sensitivity of 20/Torr or 15/mbar. Thus, for this tube, adjusting the sensitivity for a display reading of 2.0+1 will result in display of pressure in Torr (see Section 5.2.3 on page 5-4). Adjusting to 1.5+1 will result in display in mbar.

If you wish to change units, change the unit of measure on the Electrometer module as follows:

- Shut off power to the Controller.
- Remove the top cover as described in Section 2.1.1 on page 2-1.
- Locate the IG Electrometer module.
- Locate the Unit of Measure display units control switch.

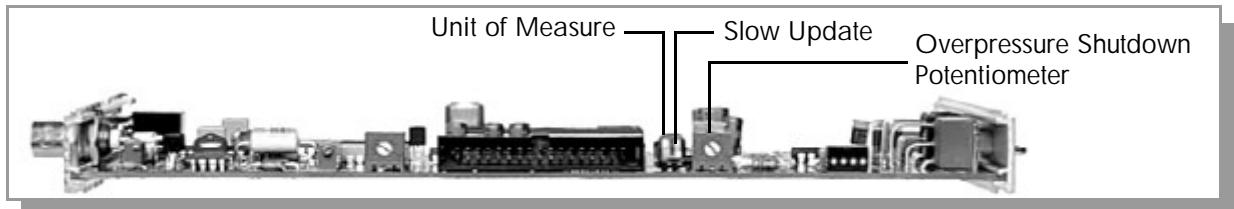

Figure 2-3 Ion Gauge Electrometer Module Top View.

- Set the switch to desired position, Off = Torr/mbar units, On = Pascal units.

NOTE: You must also change the setting of the unit of measure switch on the Dual Convectron Gauge as described in Section 2.2.2 on page 2-4.

- To change the units of measure label on the front of the Controller, open the door and lift the label card from its slot in the top of the front panel. Units of measure labels are included in the mounting hardware kit.

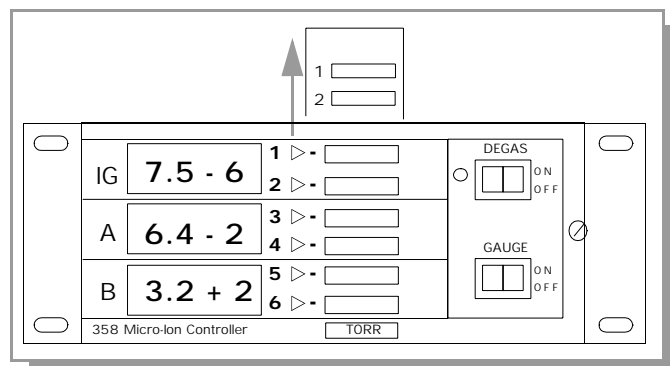

Figure 2-4 Controller Front Panel Showing Removal of Units of Measure Label Card.

2.2.1.1 Overpressure Shutdown Adjustment

This control is factory-set so the ion gauge will shut down when the pressure rises above the levels given in Table 2-1.

Table 2-1 Relay Ratings.

Pressure Range Designation	MV (medium vacuum)	HV (high vacuum)	UHV (ultrahigh vacuum)
Emission Current	20 μ A	1 mA	4 mA
Recommended Upper Limit, Torr	5×10^{-2}	8×10^{-4}	2×10^{-4}
Recommended Lower Limit, Torr	1×10^{-6}	1×10^{-7}	less than 1×10^{-9}

The overpressure shutoff point does not depend on the adjustment of the emission level within a range.

To adjust the overpressure shutoff point to a different level:

1. Maintain system pressure at the desired shutoff point.
2. Rotate the overpressure adjustment potentiometer fully counter-clockwise.
3. Turn ON the ion gauge.
4. Rotate the adjustment potentiometer clockwise slowly until the ion gauge turns off.

2.2.1.2 Changing the Display Update Rate on Electrometer Module

When "ON", the Slow Update switch on the Electrometer module enables pressure averaging. The display will be updated approximately every 3 seconds. When "OFF", the update period is approximately 0.5 seconds. Refer to Figure 2-3 on page 2-2.

2.2.2 Changing Units of Measure for the Convectron Gauge

Your instrument will have been shipped from the factory pre-set to display the units of measure, Torr, millibar, or Pa, that you requested. If you wish to change units, proceed as follows:

1. Shut off power to the Controller.
2. Remove the top cover as described in Section 2.1.1 on page 2-1.
3. Locate the Convectron Gauge module (see Figure 2-5).
4. Locate the millibar (mBar) and Pascal units switches.
5. Leave both switches "OFF" for Torr units. Close the appropriate switch for either millibar or Pa units.
6. Modify the units of measure of the Electrometer module to be consistent with the Convectron Gauge. (See Section 2.2.1 on page 2-2.)
7. Slip the label card out of the top of the front panel and apply the appropriate pressure units label (see Figure 2-4 on page 2-2).

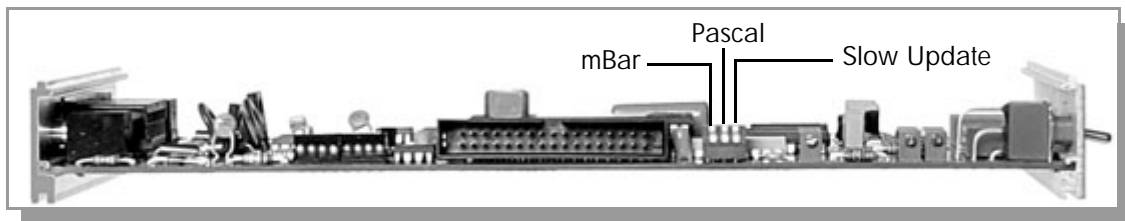

Figure 2-5 Convectron Gauge Module Top View.

8. Replace the top cover as described in Section 2.6 on page 2-17.

2.2.2.1 Display Update Rate Switch on Convectron Module

When "ON", this the Slow Update switch on the Convectron module enables pressure averaging. The display will be updated approximately every 3 seconds. When "OFF", the update period is approximately 0.5 seconds. Refer to Figure 2-5.

2.3 Process Control Setup



It is the installer's responsibility to ensure that the automatic signals provided by the product are always used in a safe manner. Carefully check the system programming before switching to automatic operation.



Where an equipment malfunction could cause a hazardous situation, always provide for fail-safe operation. As an example, in an automatic backfill operation where a malfunction might cause high internal pressures, provide an appropriate pressure relief device.

A Process Control module provides the 358 Vacuum Gauge Controller with single-pole, double-throw relays that may be controlled either by digital setpoints or by the built-in manual override switches.

2.3.1 Process Control Channel Identification Windows

A channel identification label is included in the accessory kit to enable you to customize your Series 358 Micro-Ion Vacuum Measurement System for your application (see Figure 2-6).

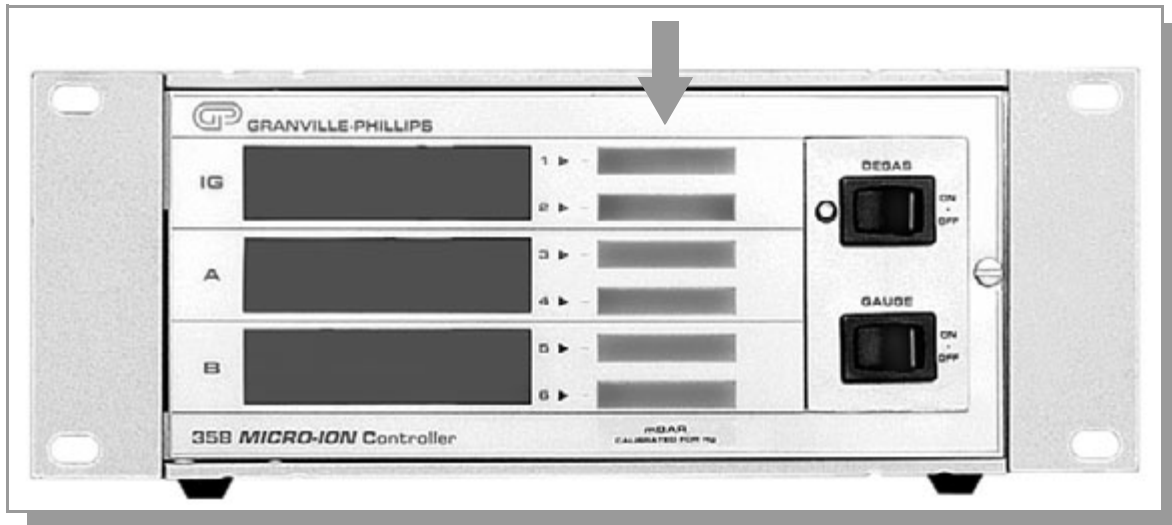

Figure 2-6 Process Control Channel Identification Windows on 358 Controller Front Panel.

2.3.2 Developing a Logic Diagram of Control Logic

Prior to connecting the Process Controls to the system, it is recommended that the following steps be followed. If application assistance is desired, contact a Helix Technology application engineer.

1. Use the catalog number on the front of the Process Control module together with Figures 2-7, 2-8, and 2-9 to identify the Process Control capability installed in your unit.
2. Even if the control logic is simple and obvious, we recommend that you develop a logic diagram of the Process Control function.
3. Prepare a specification table which lists the proposed pressure setting, system measurement point, and relay status for each Process Control channel.
4. Draw a circuit schematic which specifies exactly how each piece of system hardware will be connected to the Process Control relays.

Do not exceed the relay ratings:

Table 2-2 Relay Ratings.

Relay Configuration	SPDT (single pole, double throw)
Relay Contact Rating	5 A, 120 Vac; or 4A, 240 Vac; or 5A, 30 Vdc
Relay Contact Type	1 Form C type (gold plated for low level switching)

NOTE: *If the relay contacts are used to switch high currents, the gold plating may be consumed. This may make the contacts unsuitable for low level signal switching in the future.*

5. Attach a copy of the Process Control circuit diagram to this manual for future reference and troubleshooting.
6. The required Process Control connections may be made later. (See Section 3.6 on page 3-11.)
7. If application assistance is desired, please contact a Helix Technology Application Engineer at the number listed on the title page of this manual.

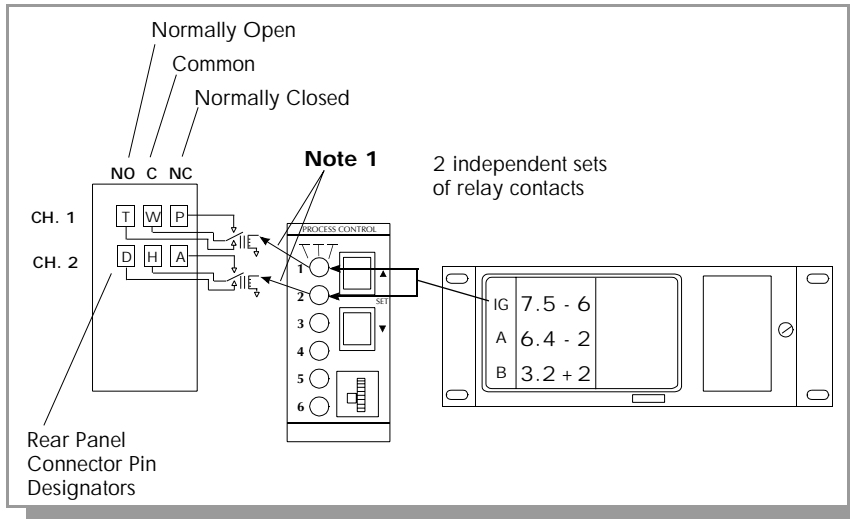

NOTE 1:

Channel 1 is user-assignable to IG1 or to IG2, or to IG1 and IG2.

Channel 2 is user-assignable to IG1 or to IG2, or to IG1 and IG2 independent of how Channel 1 is assigned.

Figure 2-7 Two Channel Process Control Option Card - Catalog No. 358004.

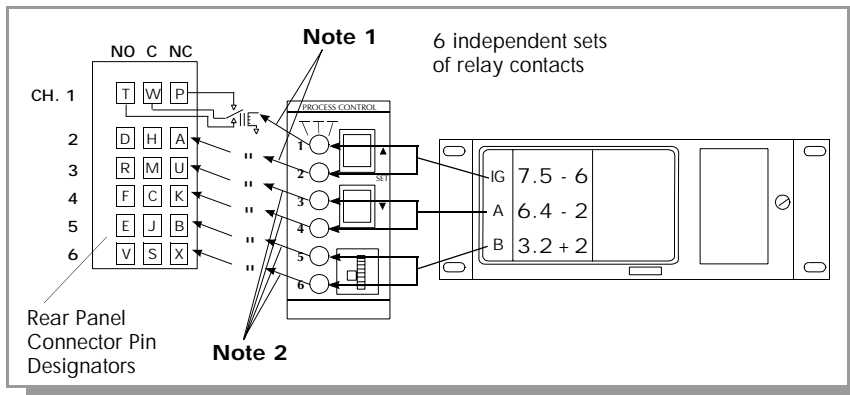

NOTE 2:

Channels 3 and 4 are factory assigned to Convectron Gauge A.

Channels 5 and 6 are factory assigned to Convectron Gauge B.

Figure 2-8 Six Channel Process Control Option Card - Catalog No. 358003.

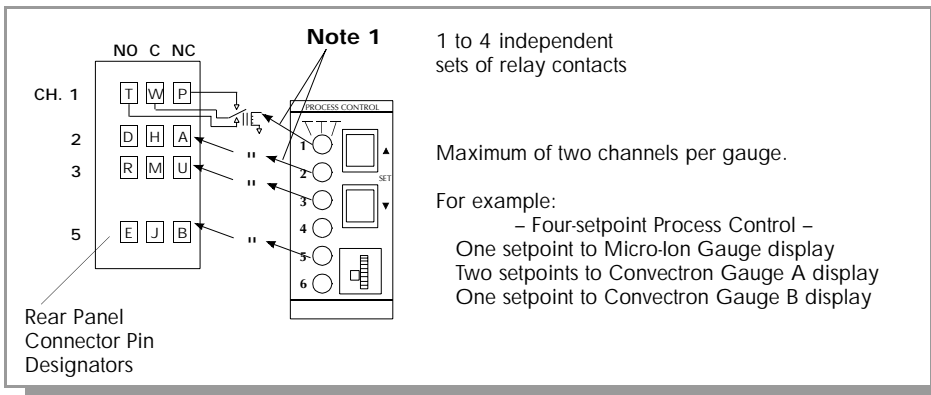

For example:
 - Four-setpoint Process Control -
 One setpoint to Micro-Ion Gauge display
 Two setpoints to Convectron Gauge A display
 One setpoint to Convectron Gauge B display

Figure 2-9 One to Four Channel Process Control Option Card - Catalog No. 358005

2.3.3 Ion Gauge Assignment for Process Control

A maximum of 6 Process Control channels are available depending on the particular option you have specified. A channel is defined as the combination of vacuum gauge indication setpoint circuitry and the associated relay which is actuated when the pressure indication corresponds to the setpoint.

Process Control channels 1 (PC1) and 2 (PC2) are controlled by the ionization gauge or gauges. Channel 1 operates relay 1. Channel 2 operates relay 2. Relays 1 and 2 are also shown as K1 and K2 on the printed circuit board for reference during IG assignment. IG1, IG2, or both can be assigned to operate either channel 1 or 2. Use Table 2-3 to assign the IG's to the channels.

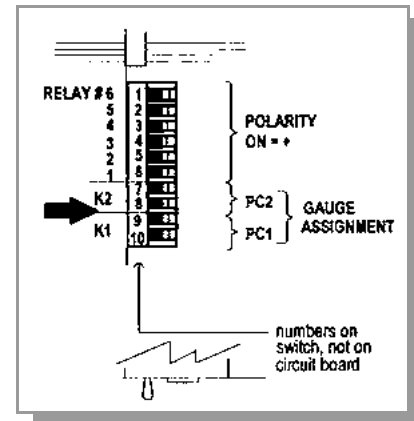

Figure 2-10 Partial Top View of Process Control Module.

Table 2-3 IG Process Control Channel Switch Settings.

Channel 1 Switch Settings	Channel 1 Function	Channel 2 Switch Settings	Channel 2 Function
	Channel 1 can turn <u>on</u> when IG1 is ON or when IG2 is ON. (factory setting)		Channel 2 can turn <u>on</u> when IG1 is ON or when IG2 is ON. (factory setting)
	Channel 1 can turn <u>on</u> when IG1 is ON and will turn <u>off</u> when IG2 is ON.		Channel 2 can turn <u>on</u> when IG1 is ON and will turn <u>off</u> when IG2 is ON.
	Channel 1 will turn <u>off</u> when IG1 is ON and can turn <u>on</u> when IG2 is ON.		Channel 2 will turn <u>off</u> when IG1 is ON and can turn <u>on</u> when IG2 is ON.
	Channel 1 will always be <u>off</u> .		Channel 2 will always be <u>off</u> .

2.3.4 Relay Polarity Setting

The relays can be set to activate as pressure either rises above or falls below the setpoint. A DIP switch is provided for each channel. Refer to the numbers on the printed circuit board—not on the switch body—for the channel number. Use Table 2-4 to assign relay polarity settings.

The switches are factory preset as shown below for relay activation below the pressure setpoint. This is most commonly desired when you want the relay to be de-energized under a high pressure condition.

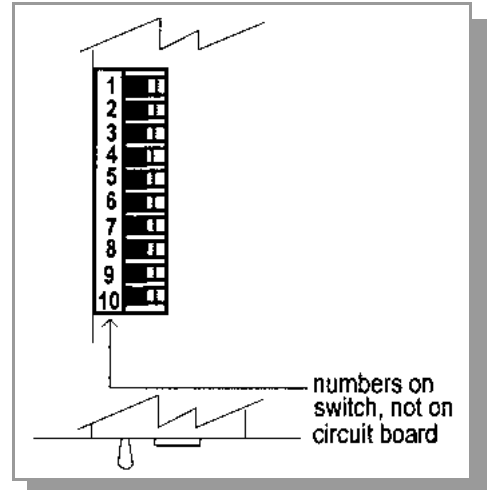

Figure 2-11 Partial Top View of Process Control Module.

Table 2-4 Relay Polarity Switch Settings.

Switch Settings	Channel Activated	Pressure Indication Relative to Setpoint	Switch Settings	Channel Activated	Pressure Indication Relative to Setpoint
OFF →	6	below*	OFF →	3	below*
ON ←	6	above	ON ←	3	above
OFF →	5	below*	OFF →	2	below*
ON ←	5	above	ON ←	2	above
OFF →	4	below*	OFF →	1	below*
ON ←	4	above	ON ←	1	above

* factory setting

2.3.5 Process Control Tips

1. The Process Control override switches can be used to hold relays on or off during initial turn on or during non-typical process conditions.
2. When IG1 and IG2 are off, channels 1 and 2 are inoperative.
3. When Convectron Gauges are disconnected, channels 3-6 are inoperative.
4. The status of relays 1 and 2 will not change during degas. They function as if the pressure reading was frozen when degas began.
5. Relay actuation occurs when the second digit pressure indication differs from the setpoint value by one display unit. A 10% hysteresis is automatically programmed into each setpoint for returning pressures. Table 2-5 illustrates this using an assumed setpoint pressure and assuming the polarity is set for falling pressure activation.

Table 2-5 Setpoint Hysteresis.

Setpoint Pressure	Pressure Change	Relay Actuation Pressure
6.30×10^{-7}	Falling	6.29×10^{-7}
6.30×10^{-7}	Rising	$6.30 \times 10^{-7} + 10\% = 7.00 \times 10^{-7}$

2.4 RS-232 Computer Interface Setup

If your Controller does not have this capability, skip to Section 2.5 on page 2-14.

This available capability permits data output to, and gauge control by, a host computer. Output is either by a command-response mechanism or by a talk-only mode which is invoked via a switch on the RS-232 board. If you have this module in your unit, configure it to your system requirements by setting the switches as directed in Section 2.4.2 on page 2-10.

A variety of baud rates and byte framing options are available, as well as switches to force the handshake lines to an “always true” condition.

358 RS-232 factory defaults are:

9600 BAUD, 8 data bits, no parity, 1 stop bit;

DCD, CTS, DSR forced “true”.

The interface protocol is set using 8 switches.

NOTE: *Internal switches are read upon 358 power up. Changes in settings will take effect upon next power-up cycle.*

2.4.1 Connector Pinouts for the RS-232 Computer Interface

This factory- or field-installed capability produces the signals shown in Table 2-6. A mating DB-25S connector is supplied in the hardware kit. Use shielded cable to minimize electromagnetic radiation or susceptibility.

Table 2-6 RS-232 Connector Pin Assignments.

Signal	Pin Number	Direction
Protective Ground	1	–
Transmitted Data	2	To Computer
Received Data	3	To 358
Request to Send (RTS)	4	To Computer
Clear to Send (CTS)	5	To 358
Data Set Ready (DSR)	6	To 358
Signal Ground (common return)	7	–
Data Carrier Detect (DCD)	8	To 358
Data Terminal Ready (DTR)	20	To Computer

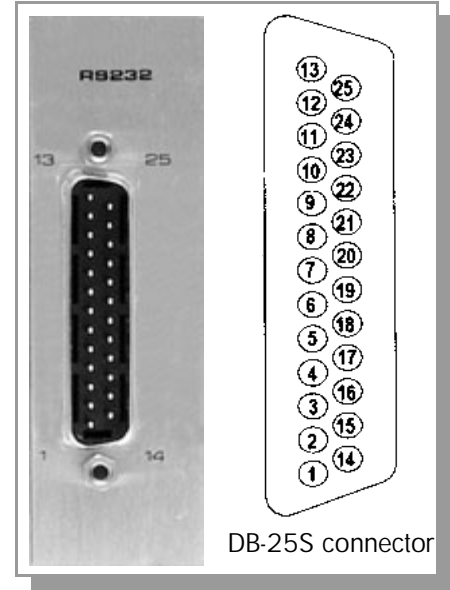

Figure 2-12 RS-232 Connector.

2.4.2 Selecting the Byte Format for RS-232 Module

2.4.2.1 Baud Rate for RS-232 Module

Dip switches 6-8 are used to control the baud rate. The settings are given in Table 2-7.

Table 2-7 Baud Rate for RS-232 Module.

S6	S7	S8	Baud Rate
On*	On*	On*	9600*
On	On	Off	4800
On	Off	On	2400
On	Off	Off	1200
Off	On	On	600
Off	On	Off	300
Off	Off	On	150
Off	Off	Off	75

* factory setting

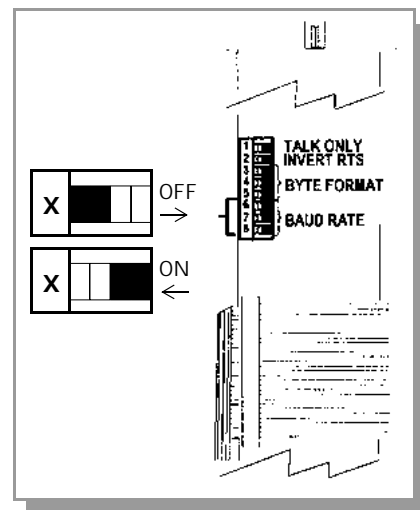

Figure 2-13 Partial Top View of RS-232 Module.

2.4.2.2 Character Framing for RS-232 Module

Switches 3-5 control number of characters, parity, and number of stop bits:

Table 2-8 Character Framing for RS-232 Module.

S3	S4	S5	Character Bits	Parity	Stop Bits
On*	On*	On*	8*	None*	1* or 2
On	On	Off	8	Even	1
On	Off	On	8	Odd	1
On	Off	Off	8	None	1
Off	On	On	7	Even	1
Off	On	Off	7	Odd	1
Off	Off	On	7	Even	2
Off	Off	Off	7	Odd	2

* factory setting

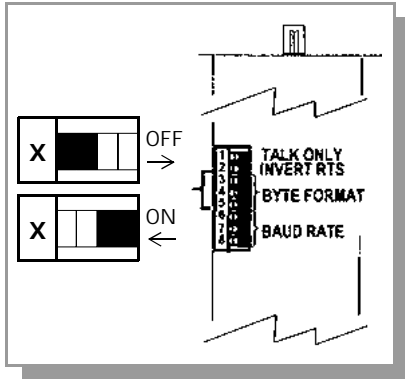

Figure 2-14 Partial Top View of RS-232 Module.

2.4.3 Talk-Only Mode for RS-232 Module

Switch S1, if off at power-up, puts the interface in talk-only mode. The pressure data from all three displays will be output in a single message string, separated by commas, approximately every 5 seconds.

Table 2-9 Talk-Only Mode for RS-232.

S1	Mode
Off	Talk-only
On	Command-response*

* factory setting

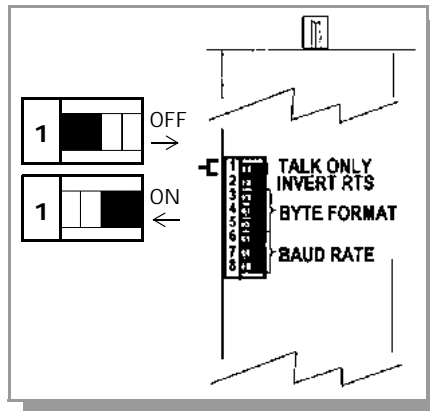

Figure 2-15 Partial Top View of RS-232 Module.

2.4.4 Handshake Line Control Switches for RS-232 Module

Refer to Section 3.7, page 3-12, for more detailed information on the handshaking mechanism.

Table 2-10 Inputs to 358 for RS-232.

Line	Switch	Description	Internal Switch Function	Factory Setting
CTS & DSR	2	CLEAR to SEND and	CTS=1 and DSR=1: When ON, forces the functions TRUE and thus assumes host is always ready to receive.	Both ON*
	3	DATA SET READY: When used, both must be TRUE in order for 358 to send the next byte in its message or data.		
DCD	1	DATA CARRIER DETECT: Must be TRUE at the time each character is received or that character will be ignored by 358.	DCD=1: When ON, forces DCD function TRUE so 358 will receive all characters sent to it (as long as RTS is in de-asserted state).	ON*

* factory setting

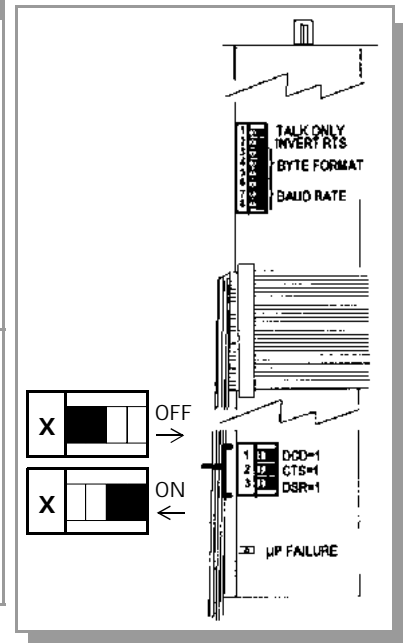

Figure 2-16 Top View of RS-232 Module.

2.4.5 Invert RTS Switch for RS-232 Module

As shipped from the factory, the request-to-send (RTS) control line is set to operate as a modem line per the RS-232 standard. In some implementations it is necessary to invert this line and hook it directly to the clear-to-send (CTS) line of the host computer. Switching S2 to OFF tells the RS-232 interface to invert the polarity of the RTS line when the 358 goes through its power-up sequence. See Section 3.7, page 3-12, for more details.

Table 2-11 Outputs from 358 for RS-232.

Line	Pin	Description	Internal Switch Function	Factory Setting
RTS	2	REQUEST TO SEND: De-asserted by 358 on power-up. Asserted by 358 upon receipt of a message terminator as a hold off to prevent the host computer from attempting to transmit data until the message just received has been parsed and a reply has been output. De-asserted after transmitting the terminator of 358's response to that message.	INVERT RTS: When OFF inverts the polarity of the RTS line allowing nonstandard connection directly to host computer CTS line. When ON, set to operate as a modem line per RS-232 standard.	ON

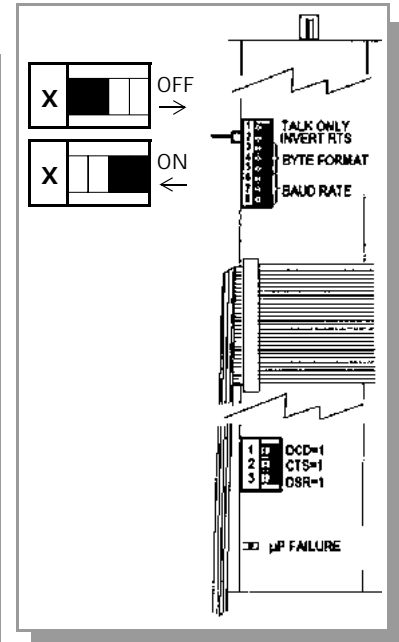

Figure 2-17 Top View of RS-232 Module.

NOTE: When the 358 receives a start bit on the received data line, it will input and buffer a character. The 358 will continue to receive and buffer characters until the terminator (LF) is received.

2.5 RS-485 Computer Interface Setup

If your Controller does not have this capability, skip to Section 2.6 on page 2-17.

RS-485 capability permits data output to, and gauge control by, a host computer. Output is by a command-response mechanism. If you have this module in your unit, configure it to your system requirements by setting the switches as directed in Section 2.5.3 on page 2-16.

A variety of baud rates and byte framing options are available, as well as switches to force the handshake lines to an “always true” condition.

The 358 RS-485 factory defaults are:

19.2K BAUD, 8 character bits, no parity, 1 stop bit, Address = 01

NOTE: Internal switches are read upon 358 power up. Changes in settings will take effect upon next power-up cycle.

2.5.1 Connector Pinouts for the RS-485 Computer Interface

Connectors J1 and J2 on the rear panel are wired in parallel and are interchangeable. Connection can easily be made by “daisy chaining” gauge Controllers together with the signal from the host computer going into one connector then out the other to another gauge Controller, and so on.

The maximum total cable length is 4,000 ft. The maximum number of devices connected is 32.

Table 2-12 Connector Pinouts for RS-485.

Signal	Pin #
+TX	4
-TX	5
+RX	8
-RX	9
Ground	3

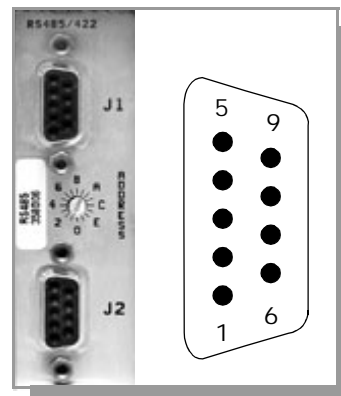

Figure 2-18 RS-485 Connector.

1. Connect TX on the gauge Controller to RX on the host computer and connect RX on the gauge Controller to TX on the host computer. To prevent problems with RFI, 120 ohm terminator resistors should be connected, one from pin 4 to 5 and another from pin 8 to 9, at each end of the interface wiring, usually at the computer and the last device at the other end of the string.
2. Connect TX to TX and RX to RX on all 358's. If the computer sends and receives data on 2 wires, connect +TX to +RX and connect -TX to -RX.
3. The polarity may have to be reversed on the computer and other instruments—you may have to try it both ways. No damage will result if connections are wrong.

The timing of the data transfer is shown in Figure 2-19 on page 2-15.

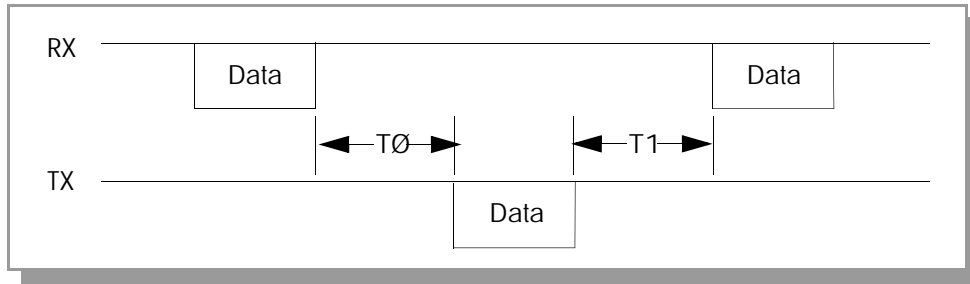

Figure 2-19 RS-485 Data Timing.

$T_0 = 10 \text{ to } 13 \text{ mS} + 10 \text{ bits with S2.1 OFF.}$

$T_0 = 700 \text{ } \mu\text{S with S2.1 ON.}$

$T_1 = 300 \text{ } \mu\text{S minimum.}$

2.5.2 RS-485 Address

The Address switch on the RS-485 module on the back of the Controller (see Figure 2-18 on page 2-14) and Switch S1 (see Figure 2-20) determine the RS-485 module's address. This address can be any hex code from 00 to FF.

The Address switch on the RS-485 module on the back of the Controller determines the value of the least significant digit and S1 determines the value of the most significant digit. S1 switch positions are binary. The weight of each switch when OFF is given in Table 2-13.

Table 2-13 Weight when OFF of S1 Switches for RS-485.

S1	Weight
S1.1	10 Hex
S1.2	20 Hex
S1.3	40 Hex
S1.4	80 Hex

- To prevent data contentions, no two of the 358's modules should be set with the same address.
- It is not recommended that address 00 be used because some manufacturers use this address for configuration.

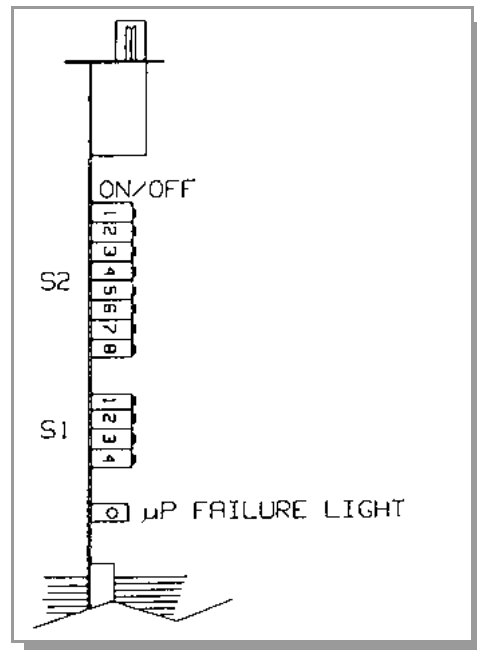

Figure 2-20 RS-485 Addressing and Data Format.

2.5.3 Selecting the Byte Format for RS-485 Module

2.5.3.1 Baud Rate for RS-485

Baud rate for the RS-485 computer interface is determined by S2.6, S2.7, S2.8.

Table 2-14 Baud Rate for the RS-485 Module.

S2.6	S2.7	S2.8	Baud Rate
On	On	On	19200*
On	On	Off	9600
On	Off	On	4800
On	Off	Off	2400
Off	On	On	1200
Off	On	Off	600
Off	Off	On	300
Off	Off	Off	150

* factory setting

2.5.3.2 Character Framing for the RS-485 Computer Interface

Character framing for the RS-485 computer interface is determined by S2.3, S2.4, S2.5.

Table 2-15 Character Framing for the RS-485 Module.

S2.3	S2.4	S2.5	Character Bits	Parity	Stop Bits
On	On	On	8	None	2
On	On	Off	8	Even	1
On	Off	On	8	Odd	1
On	Off	Off	8*	None*	1*
Off	On	On	7	Even	1
Off	On	Off	7	Odd	1
Off	Off	On	7	Even	2
Off	Off	Off	7	Odd	2

* factory setting

2.5.4 Response Delay for the RS-485 Computer Interface

Switch S2.1 (Figure 2-20 on page 2-15) enables a delay in the response from the module of 13 MS + 10 bits when OFF. When S2.1 is ON the delay is 700 μ S. Default is ON.

2.6 Replacing Controller Cover

Assuming you have completed the above instructions, the Controller setup is now complete. Replace the top cover. Make sure the door hinge pin is seated correctly. Replace the four top cover Phillips head screws (or three screws plus bracket screw).

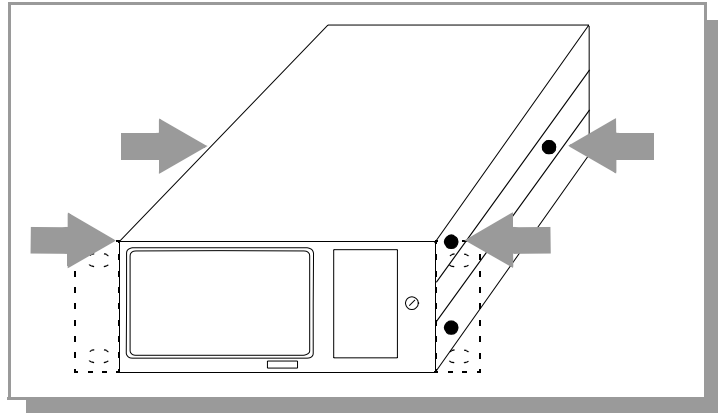

Figure 2-21 Location of Screws for Replacing Top Cover.

NOTES

Installation



It is the installer's responsibility to ensure that the automatic signals provided by the product are always used in a safe manner. Carefully check the system programming before switching to automatic operation.



Where an equipment malfunction could cause a hazardous situation, always provide for fail-safe operation. As an example, in an automatic backfill operation where a malfunction might cause high internal pressures, provide an appropriate pressure relief device.

3.1 Gauge Installation Tips

For best results locate pressure gauges close to the point where pressure is to be measured. Gas sources, long tubulation or other constrictions can cause large errors in indication. Note that if placed near the pump, the pressure in the gauge may be considerably lower than in the rest of the system. If placed near a gas inlet or source of contamination, the pressure in the gauge may be much higher.

To minimize temperature effects, locate pressure gauges away from internal and external heat sources in a region where the ambient temperature is reasonably constant.

Parts of the gauge can get quite hot during degassing, especially if there is poor ventilation. This will not damage the gauge. However, care should be taken to prevent low temperature rated materials such as plastic wire insulation from touching hot parts of the gauge.

3.1.1 EMC Compliance

In order to comply with the standards for immunity as called for by the EMC Directive, careful consideration to grounding and shielding of instrumentation cables is required. User supplied cables must have the drain shield of the cable connected to chassis ground. Immunity to radiated and conducted RF energy in industrial environments will depend on cable construction and routing. The Series 358 Micro-Ion Vacuum Measurement System system will perform within the typical uncertainty of a Bayard-Alpert ion gauge system when subjected to industrial levels of RF energy.

3.1.2 Cable Installation Statement

It is intended that all wiring either to or from the 358 Controller unit, whether supplied by Helix Technology or not, be installed in accordance with the safety requirements of NEC/NFPA 70. Cables provided by Helix Technology for connection to sensors or transducers is, at a minimum, designed for use as Appliance Wiring Material (UL category AVLV2), and is constructed of appropriate material and dimensions for the voltages and currents provided by the 358 Controller unit. It is emphasized that it is the user's responsibility to install cables to/from the 358 Controller whether provided by Helix Technology, or not, in accordance with the applicable local, state and national safety requirements.

Raceway and/or conduit may be needed for certain installations.

3.1.3 Environmental Conditions

- Indoor Use.
- Altitude up to 2000 meters.
- Temperature 0 °C to 40 °C.
- Maximum relative humidity 80% for temperatures up to 31 °C decreasing linearly to 50% relative humidity at 40 °C.
- Transient overvoltages according to INSTALLATION CATEGORY (over-voltage category) II.
- POLLUTION DEGREE 2 in accordance with IEC664.

3.2 Controller Installation

The Series 358 Controller is designed to operate a Series 355 Micro-Ion Gauge. This is an all-metal miniature gauge with dual yttria-coated iridium or dual tungsten filaments and a nominal sensitivity of 20/Torr.

The Micro-Ion Gauge Electrometer Module provides ion gauge pressure readout from 1×10^{-10} Torr (1.3×10^{-10} mbar or 1.3×10^{-8} Pascal) to 5×10^{-2} Torr, N₂ equivalent, depending on the emission current used.

Adjustment is provided for gauge sensitivity. Adjustment and an internal switch allow change to mbar or Pascal pressure units, and a user selectable “slow update” feature triggers measurement averaging, resulting in a display update frequency of about once every three seconds. The overpressure shutdown threshold is internally adjustable.

Internal failure-indicator LEDs aid diagnosis of problems by indicating certain out-of-bounds electronic conditions (see Table 6-1 on pages 6-2, 6-3).

3.2.1 Installing the Controller

1. Provide adequate ventilation for the Controller to dissipate 15 watts.
2. Do not mount the Controller above other equipment that generates excessive heat.
3. This product is designed to operate over the range 0-50 °C. Ambient temperatures above 50 °C may damage the product. For optimum electrometer calibration stability, the Controller ambient temperature should be 25 ± 5 °C.

3.2.2 Installation Hardware Part Numbers

Table 3-1 Installation Hardware Part Numbers.

Part Number	Adapter Hardware Description
370010	To mount Controller only on left or right side of a 19 in. rack (specify side)
370011	To mount Controller in center of 19 in. rack
370021	To mount two Controllers side-by-side in a 19 in. rack

3.2.3 Mounting Configurations

Figure 3-1 illustrates the various configurations available for mounting the Series 358 Micro-Ion Vacuum Gauge Controller.

NOTE: The Series 358 Micro-Ion Vacuum Measurement System should be mounted in a location with free air flow and ambient temperature less than 40°C.

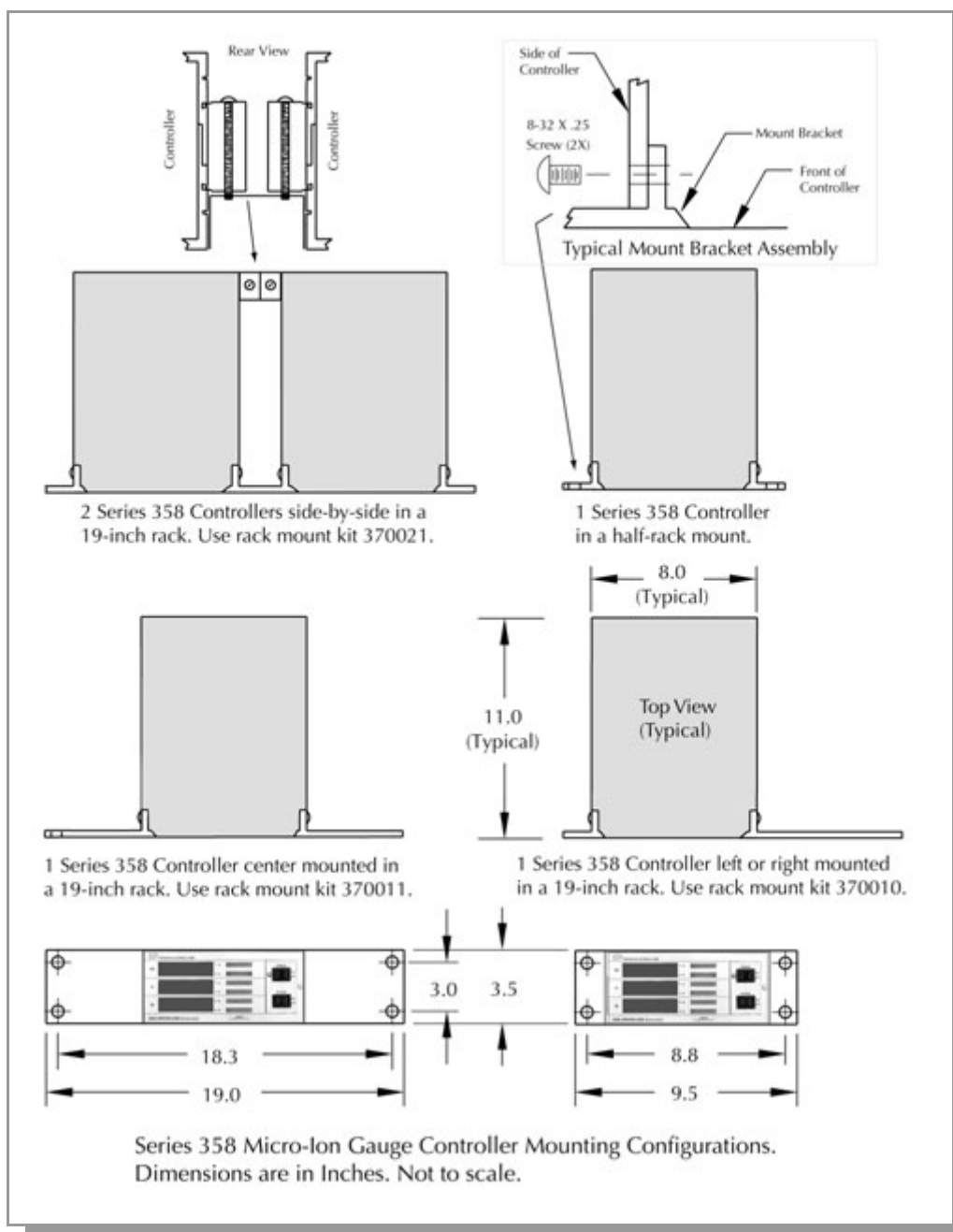

Figure 3-1 358 Controller Mounting Configurations.

3.2.4 Line Voltage

The Series 358 Controller will operate over a line voltage range of 100 Vac to 240 Vac, 50-60 Hz. All that is required is that a line cord be selected to match your available power receptacle to the power input connector located on the rear of the Controller.

Fuse type: 5 x 20mm time lag (T) - low breaking capacity
1.6 A, 250 V, Manufacturer - Schurter, Part No. - FST034.3119

Replacement fuses available from Helix Technology at the address on the title page of this manual.

3.2.4.1 Fuse Replacement Instructions:

1. On the rear panel, turn the power switch OFF and unplug the power cord.
2. Use a flat tip screwdriver (or similar tool) to turn the fuseholder counterclockwise.
3. Pull out the fuseholder, then remove and replace the fuse.
4. Insert the fuseholder and turn clockwise to lock position.
5. Plug in the power cord and turn the power switch ON.

3.3 Convectron Gauge Installation



When high voltage is present, all exposed conductors of a vacuum must be maintained at earth ground.

Under certain conditions, dangerous high voltage can be coupled directly to an ungrounded conductor through a gas almost as effectively as through a copper wire connection. This hazard, which is not peculiar to this product, is a consequence of the ability of an electric current to flow through a gas under certain circumstances. A person may be seriously injured, or even killed by merely touching an exposed ungrounded conductor at high potential.

When high voltages are used within the vacuum system and the Convectron Gauge envelope is not reliably grounded through its vacuum connection, either a separate ground wire must be added, or the envelope must be shielded to positively prevent human contact. The gauge envelope may be grounded by using a metal hose clamp on the gauge connected by a #12 awg copper wire to the grounded vacuum chamber.

High voltage can couple through a gas to the internal electrodes of a gauge. Do not touch the exposed pins on any gauge installed on a vacuum system where high voltage is present.

- Cleanliness pays. Keep the port cover in place until moments before installation.
- For proper operation above about 1 Torr, install Convectron Gauges with the gauge axis horizontal. To minimize pressure indication errors, avoid installing the Convectron Gauge where it will vibrate. Vibration causes convection cooling of the sensor and will cause the pressure indication to be high.
- Do not mount the gauge in a manner such that deposition of process vapors upon the internal surfaces can occur through line-of-sight access to its interior. If condensates may be present, orient the port downward to help liquids drain out.
- Mounting clearance dimensions are shown in Figure 3-2.

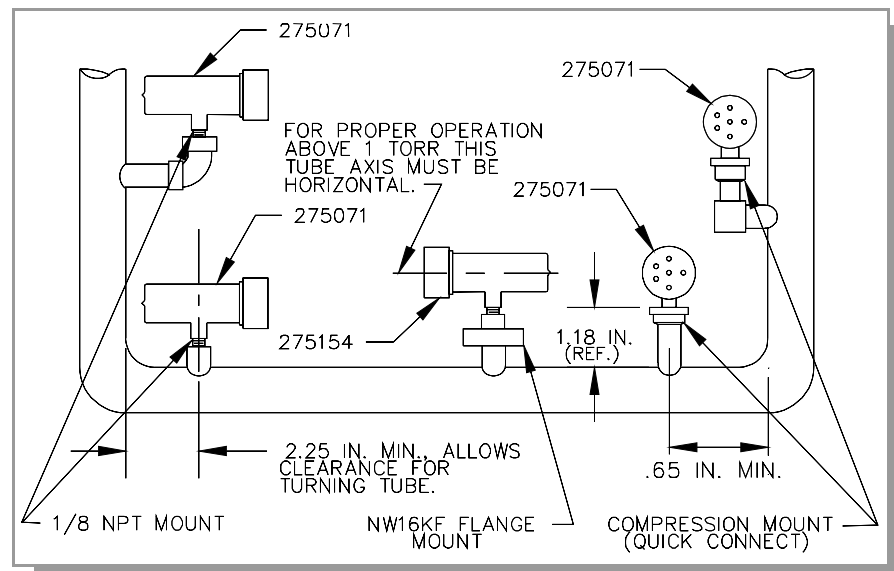

Figure 3-2 Convectron Gauge Installation.

3.3.1 Mounting Options

3.3.1.1 Compression Mount/Quick Connect

Do not use for positive pressure applications. The gauge may be forcefully ejected.

The gauge port is designed to fit a standard 1/2 in. compression/quick connect mounting such as an Ultra-Torr¹ fitting.

Remove the caplug from the gauge tube port, insert the gauge tube port into the compression fitting and finger tighten the press ring. If a seal is not achieved it may be due to extreme cleanliness of the O-ring. A light film of vacuum grease such as Apiezon² will ensure sealing and is normally preferable to the use of pliers or pipe wrench to further tighten the press ring. You may point the electrical pins of the gauge tube anywhere you wish in a 360° horizontal circle for optimum routing of the gauge tube cable.

3.3.1.2 1/8 NPT Mount

Fits standard 1/8 NPT female fitting. Wrap the threads of the gauge port with TEFLON³ tape and hand tighten. Do not use a wrench or tool. Tighten only sufficiently to achieve a seal.

3.3.1.3 VCR®/VCO® Mount

Remove the plastic or metal bead protector cap from the bead. When using gasket, place it into the female nut where applicable. Assemble components and snug finger-tight. While holding a back-up wrench stationary, tighten the female nut 1/8 turn past finger-tight for 316 stainless steel and nickel gaskets; or 1/4 turn past finger-tight for copper and aluminum gaskets.

3.3.1.4 NW10KF, NW16KF, NW25KF and NW40KF Flange Mount

The KF mounting system requires an O-ring and centering ring to be placed between the mating flanges. The flanges are then held together with the aluminum flange clamp by tightening the wing nut. Maximum pressure for this style mounting system is 1000 Torr absolute.

3.3.1.5 ConFlat Flange Mount

1. To minimize possibility of leaks with ConFlat flanges, use high strength stainless steel bolts and a new, clean OFHC copper gasket. Avoid scratching the seal surfaces. To avoid contamination, do not use nonmetal gaskets.
2. After finger tightening all bolts, continue tightening about 1/8 turn in crisscross order, e.g., 1, 4, 2, 5, 3, 6, 4, . . . until flanges are in contact. After contact, further tighten each bolt about 1/16 turn.

1. Ultra-Torr, VCR, and VCO are registered trademarks of Cajon Co.

2. Apiezon is a trademark of James G. Biddle Co.

3. TEFLON is a registered trademark of DuPont.

3.4 Grounding the System

1. Connect a heavy duty ground wire #12 AWG or larger from the ground lug on the back of the Controller (see Figure 1-5 on page 1-5) to your facility grounding electrode system. This will provide an earth ground for the Controller in the event the interconnect cables are not in place. Do not connect the ground lug to the vacuum system or other component. Connect it directly to the facility grounding system such as a grounded outlet box or a grounded copper water supply pipe. Do not rely on small metal water lines to ground a component. Later on someone may replace the metal tubing with plastic tubing thus unwittingly causing a potentially dangerous situation.



Be aware that an electrical discharge through a gas may couple dangerous high voltage directly to an ungrounded conductor almost as effectively as would a copper wire connection. A person may be seriously injured or even killed by merely touching an exposed ungrounded conductor at high potential.

This hazard is not unique to this product.

2. Provide a connection to ground for other instruments with electrodes in the vacuum system possibly exposed to high voltage electrical discharges.
3. Provide a connection to ground for each ungrounded metal component in, on or around the vacuum system, including the gauge envelopes, which personnel may touch and which can potentially be exposed to high voltage electrical discharges within the vacuum system. For example, a metal bell jar resting on an organic O-ring must be connected to ground if an ionization gauge is to be used or if other high voltage sources are present in the vacuum system.



Compliance with the usual warning to connect the power cable only to a properly grounded outlet is necessary but not sufficient for safe operation of a vacuum system with this or any similar high voltage producing product. Grounding this product does not and cannot guarantee that other components of the vacuum system are all maintained at earth ground.



All conductors in, on, or around the vacuum system that are exposed to potential high voltage electrical discharges must either be shielded at all times to protect personnel or must be connected to earth ground at all times.

3.4.1 System Ground Test Procedure

(Refer to the Safety Instructions on beginning on v for further information).

- Physically examine the grounding of both the 358 Controller and the vacuum chamber. Is there an intentional heavy duty ground connection to all exposed conductors on the vacuum chamber? There should be.
- Note that a horizontal "O" ring or "L" ring gasket, without metal clamps, can leave the chamber above it electrically isolated.
- Power can be delivered to mechanical and diffusion pumps without any ground connections to the system frame or chamber.
- Water line grounds can be lost by a plastic or rubber tube interconnection. What was once a carefully grounded vacuum system can, by innocent failure to reconnect all ground connections, become a very dangerous device.

3.4.1.1 Procedure for Testing Grounding of Systems

Use the following procedure to test each of your vacuum systems that incorporate an ionization gauge.

NOTE: This procedure uses a conventional volt-ohm meter (VOM) and a resistor (10 ohm, 10 watt).

1. With the Controller turned off, test for both DC and AC voltages between the metal parts of the vacuum chamber and the power supply chassis.
2. If no voltages exist, measure resistance. The resistance should not exceed 2 ohms. Two ohms, or less, implies commonality of these grounds that should prevent the plasma from creating a dangerous voltage between them. This test does not prove that either connection is earth ground, only that they are the same. If more than 2 ohms is indicated, check with your electrician.
3. If AC or DC voltages exist and are less than 10 volts, shunt the meter with a 10 ohm, 10 watt resistor. Repeat the voltage measurement. With the shunt in place across the meter, if the voltage remains at 83% or more of the unshunted value, commonality of the grounds is implied. Repeat the measurements several times to be sure that the voltage ratio is not changing with time. If,

$$\frac{\text{Voltage (shunted)}}{\text{Voltage (unshunted)}} = 0.83 \text{ or more,}$$

this should prevent the plasma from creating a dangerous voltage between these grounds. If more than 10 volts exists between grounds, check with your electrician.

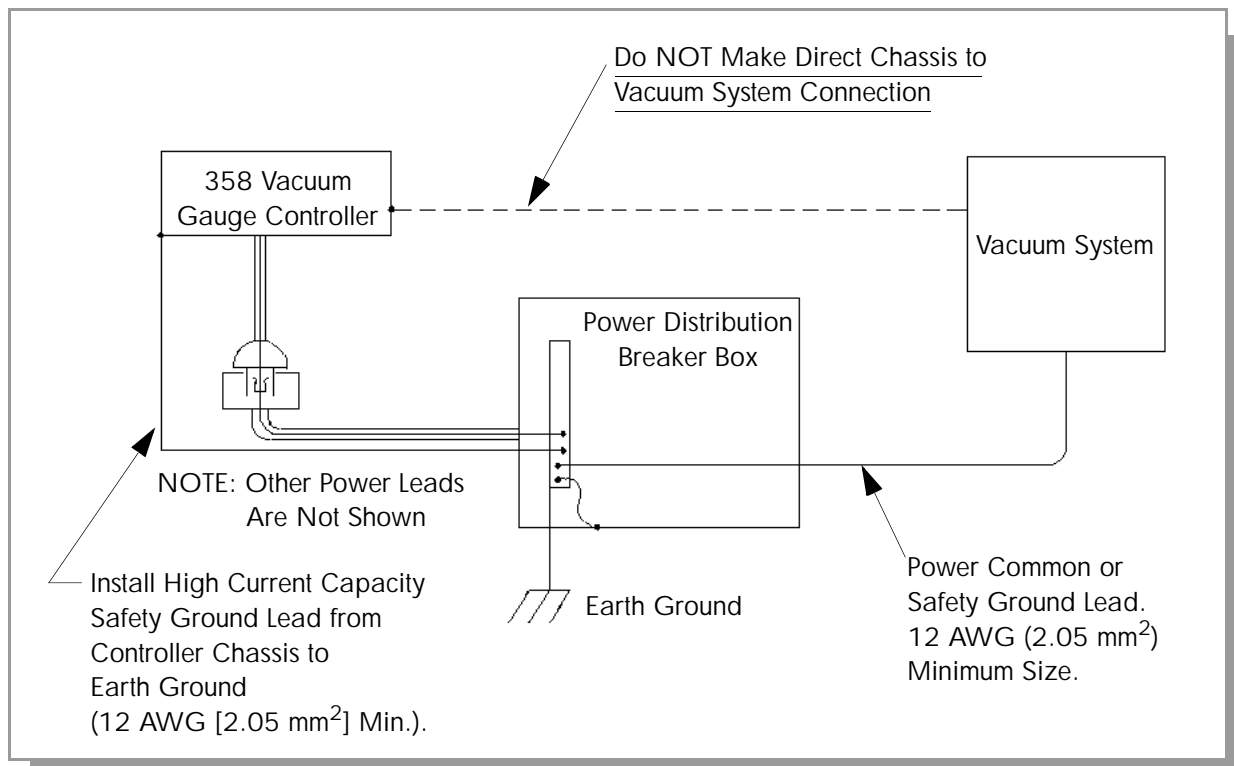

Figure 3-3 Correct System Grounding.

4. If the voltage calculation in Step 3 is less than 0.83, due to the placement of the shunt, it complicates the measurement. The commonality of the grounds may be satisfactory and the coupling poor, or the commonality could be poor! Your electrician should be asked to check the electrical continuity between these two ground systems. The placement of a second ground wire, (dashed line in Figure 3-3), between the vacuum chamber and the Series 358 Controller chassis is not a safe answer for large currents could flow through it. Professional help is recommended.

3.5 Connecting Analog Outputs

3.5.1 Electrometer Module Analog Output Signal

This voltage is proportional to the logarithm of the pressure, scaled to 1 volt per decade with 0 volts at 1×10^{-11} Torr. When the IG is turned off, the output will switch to slightly over +10 V.

A standard 1/8" miniature phono jack connector is supplied.

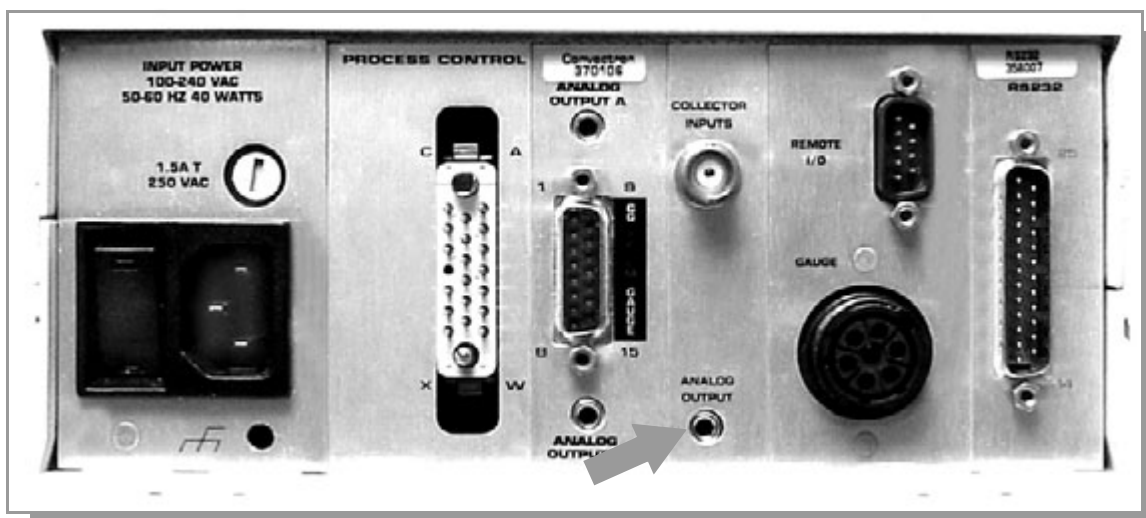

Figure 3-4 Micro-Ion Gauge Analog Output Connector Location on Rear Panel.

3.5.2 Convector Gauge Analog Output Signal

If you have Convector Gauge capability installed, signal voltages proportional to the logarithm of the Convector Gauge display indications are provided on the back of the Convector Gauge module via a standard 1/8" miniature phono jack. Two mating connectors are supplied with this capability. See Section 4.6 on page 4-15 pertaining to the characteristics of these signals.

An analog output jack is provided on the rear panel. This is a DC voltage proportional to the logarithm of the pressure, scaled to 1 volt per decade:

0 volts = 1×10^{-4} or less, torr or mbar, 1 volt = 1×10^{-3} , etc.

For pascal units, the analog output will be scaled to 0 volts = 1×10^{-2} Pa.

Internal offset adjustments are provided that allow a shift in the analog output at 10^{-4} Torr away from 0 volts to anywhere in the range -7 to +1V. This adjustment does not affect the slope of the analog output vs pressure curve.

Standard 1/8" miniature phono jack connectors are provided for the analog output. (See Figure 3-5.)

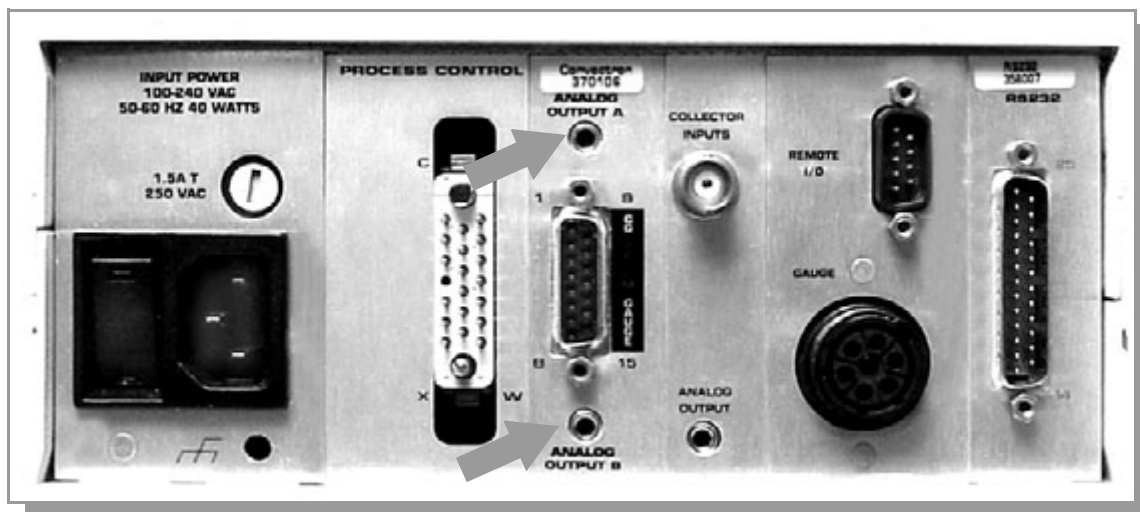

Figure 3-5 Convector Gauge Analog Output Connectors A and B on Rear Panel of Controller.

3.6 Connecting Process Control Relays

Instructions for setting up this module are in Section 2.3 Process Control Setup on page 2-4.

The process control connector is embossed with letters identifying corner pins. Table 3-2 shows the letters designating the 3 pins assigned to each of the 6 setpoint channels.

Table 3-2 Process Control Output Connector Pin Assignments.

Process Control Channel	IG		A		B	
	1	2	3	4	5	6
Common (or Pole)	W	H	M	C	J	S
Normally Closed (NC)	P	A	U	K	B	X
Normally Open (NO)	T	D	R	F	E	V
CHASSIS GND – PIN L			NO CONNECTION – PIN N			



Figure 3-6 Process Control Output Connector.



It is the installer's responsibility to ensure that the automatic signals provided by the product are always used in a safe manner. Carefully check the system programming before switching to automatic operation.



Where an equipment malfunction could cause a hazardous situation, always provide for fail-safe operation. As an example, in an automatic backfill operation where a malfunction might cause high internal pressures, provide an appropriate pressure relief device.

- Using Table 3-2 and Figure 3-6 and circuit schematics you have prepared, make up a cable to connect the various system components which are to be controlled. Unambiguous labeling of each lead will help prevent costly mistakes.
- Ensure that the Process Control channel override switches are all set to OFF.
- Connect the component end of the cable to the system component to be controlled.
- Plug the connector into the back of the Controller.
- Refer to Section 4.7 on page 4-16 for instructions for setting setpoints.

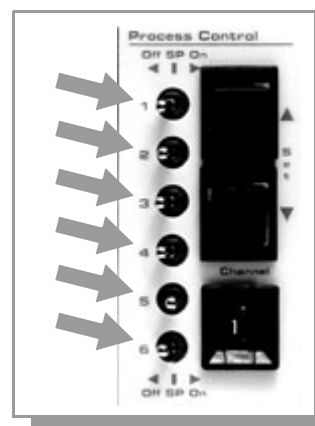

Figure 3-7 Override Switches on Front Panel of Controller (with Door Open).

3.7 Connecting the RS-232 Computer Interface

Instructions for setting up this interface are in Section 2.4 on page 2-9.

The DTR line is set true on power up to indicate it is on line. When the 358 receives a start bit on the received data line it will input and buffer a character. The DCD line must be true at the time each character is received or that character will be ignored. The 358 will continue to receive and buffer characters until the terminator (LF) is received.

Upon receiving the terminator, the 358 will assert the RTS line as a holdoff, to prevent the host computer from attempting to transmit further data until the message just received has been decoded and a reply has been output.

During output of the reply, the incoming handshake lines CTS, and DSR are tested prior to beginning transmission of each character. The 358 will wait until both are true before beginning transmission of a character, and will not test them again until ready to begin transmitting the next.

After transmitting the terminator, the 358 will negate RTS and wait for the next incoming message.

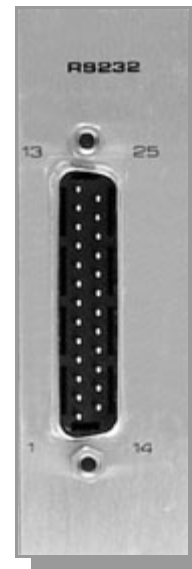

Figure 3-8 Controller Rear Panel with RS-232 Option.

3.7.1 RS-232 Command Summary

CTS, DSR

Set the computer to indicate that 358 may output the next byte in its message. As shipped from the factory these lines are forced "TRUE" by the switch settings of the 358 RS-232 printed circuit board. Thus the 358 will automatically assume the host is ready to receive. See Figure 2-16 on page 2-12 for the location of these switches.

DCD

Tested by 358 when a character is received. The character will be ignored unless DCD is "TRUE". As shipped from the factory, this line is forced "TRUE" by the switch settings.

DTR

Always asserted by 358. A "power on" indication.

RTS

Negated by 358 on power-up. Asserted by 358 upon receipt of a message terminator. Negated after transmitting the terminator of 358's response to that message.

3.7.2 Reversing the Polarity of RTS

If switch 2, is open on power-up, the 358 will apply the opposite polarity to RTS from that described above. When used in this mode RTS may be connected to the CTS input of the host computer. This violates the RS-232 standard, but is a commonly used implementation.

3.8 Connecting the RS-485 Computer Interface

Instructions for setting up this interface are in Section 2.5 on page 2-14.

Connectors J1 and J2 on the rear panel are wired in parallel and are interchangeable. Connection can easily be made by “daisy chaining” gauge Controllers together with the signal from the host computer going into one connector then out the other to another gauge Controller and so on.

The maximum total cable length is 4000 ft. The maximum number of devices connected is 32.

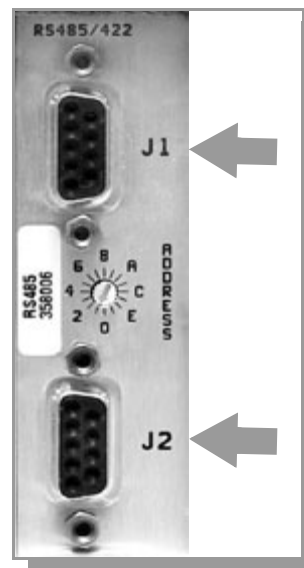

Figure 3-9 Controller Rear Panel with RS-485/422 Option.

NOTES

Preparing for Operation

4.1 Preparing for Pressure Measurement

1. The steps in this Section (4.1) assume:
 - a. Your 358 Micro-Ion Vacuum Gauge System has been properly set up and installed per the instructions in Chapters 2 and 3.
 - b. The gas in your vacuum system is air or N_2 . For other gases you must follow the instructions in Section 4.3 on page 4-3 for using Convectron Gauges.
 - c. That you are reasonably familiar with the general theory of operation of hot cathode ionization gauges and thermal conductivity gauges.

We recommend you consult a good text book if you are unfamiliar with vacuum technology or require more information on the general theory of operation of an ionization gauge or thermal conductivity gauge. Extremely useful information is provided in the following references.

- Dushman, S., Lafferty, J. M., *Scientific Foundations of Vacuum Technique*, John Wiley & Sons, Inc., Second Edition, New York, 1962.
 - Redhead, P. A., et al., *Ultrahigh Vacuum*, Chapman and Hall, London, 1968.
 - O'Hanlon, J. F., *A User's Guide to Vacuum Technology*, John Wiley & Sons, New York, 1980.
2. Turn on the 358 System by pressing the Controller power switch labeled ON. See Figure 4-1.

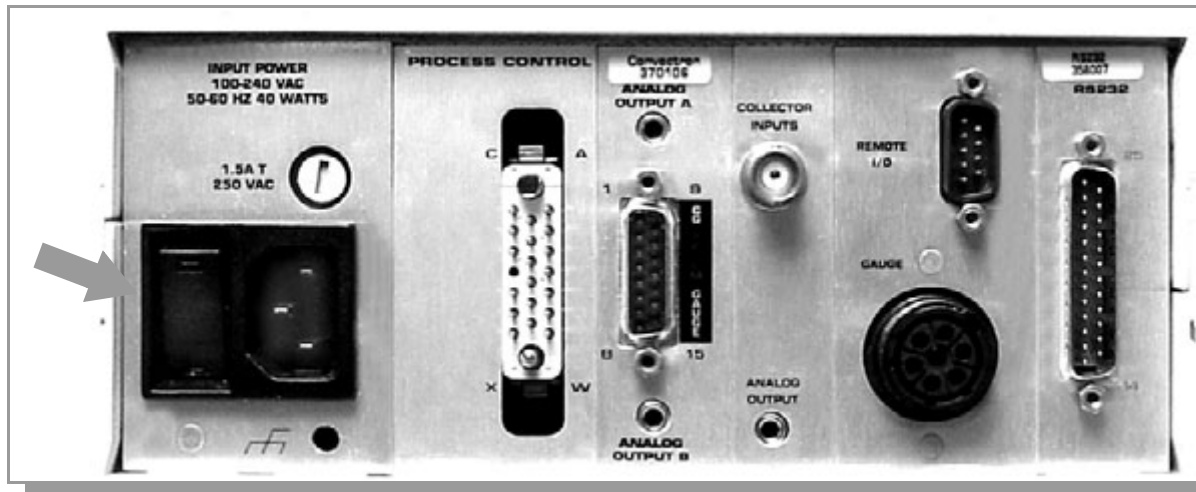

Figure 4-1 358 Controller Rear Panel Showing Power ON Switch.

3. Convectron Gauge equivalent N_2 pressures will be displayed whenever power is applied if the gauges and cables are installed. See Section 4.3 on page 4-3 for information on Convectron Gauge pressure measurement.
4. The N_2 equivalent pressure within IG1 and IG2 will be displayed in the pressure units you have specified (Torr, mbar or Pa). See Section 2.2 on page 2-2 to change pressure units.

4.1.1 Alternate ON/OFF Gauge Control

The 358 Gauges may be turned on and off in the following ways:

- Using the front panel Micro-Ion Gauge “momentary” GAUGE On/Off switch. See Figure 4-2.
- Automatically using the Auto On function of the Convectron Gauge module. See Section 4.4.1 Filament Auto Turn-On on page 4-13.
- Using the RS-232 or RS-485 Computer Interface modules. See Section 4.8.1 Command Syntax for the RS-232 Computer Interface on page 4-17 or Section 4.9.1 Command Syntax for the RS-485 Computer Interface on page 4-20.

In addition, the Micro-Ion Gauge will be automatically turned off by excessive pressure.

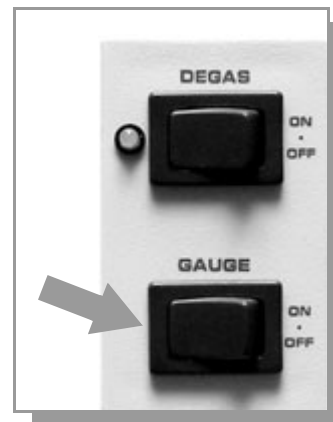

Figure 4-2 Micro-Ion “Momentary” On/Off Switch.

4.2 Micro-Ion Analog Output Signal

A signal voltage proportional to the logarithm of the Micro-Ion pressure indication is provided on the back of the electrometer module via a standard 1/8 in. miniature phono jack.

Normal Measurement Operation

$$\begin{aligned} \text{Pressure indication, } P_i &= 10^{V-11} \text{ Torr or mbar} \\ &= 10^{V-9} \text{ Pascal} \end{aligned}$$

When Degassing

$$\begin{aligned} \text{Pressure indication, } P_i &= 10^{V-13.92} \text{ Torr or mbar} \\ &= 10^{V-11.92} \text{ Pascal} \end{aligned}$$

When gauge is off, V is = 11 volts

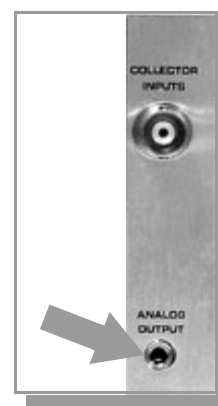

Figure 4-3 Electrometer Analog Output Jack on Rear Panel.

This signal voltage is determined by the pressure indicated on the IG display.

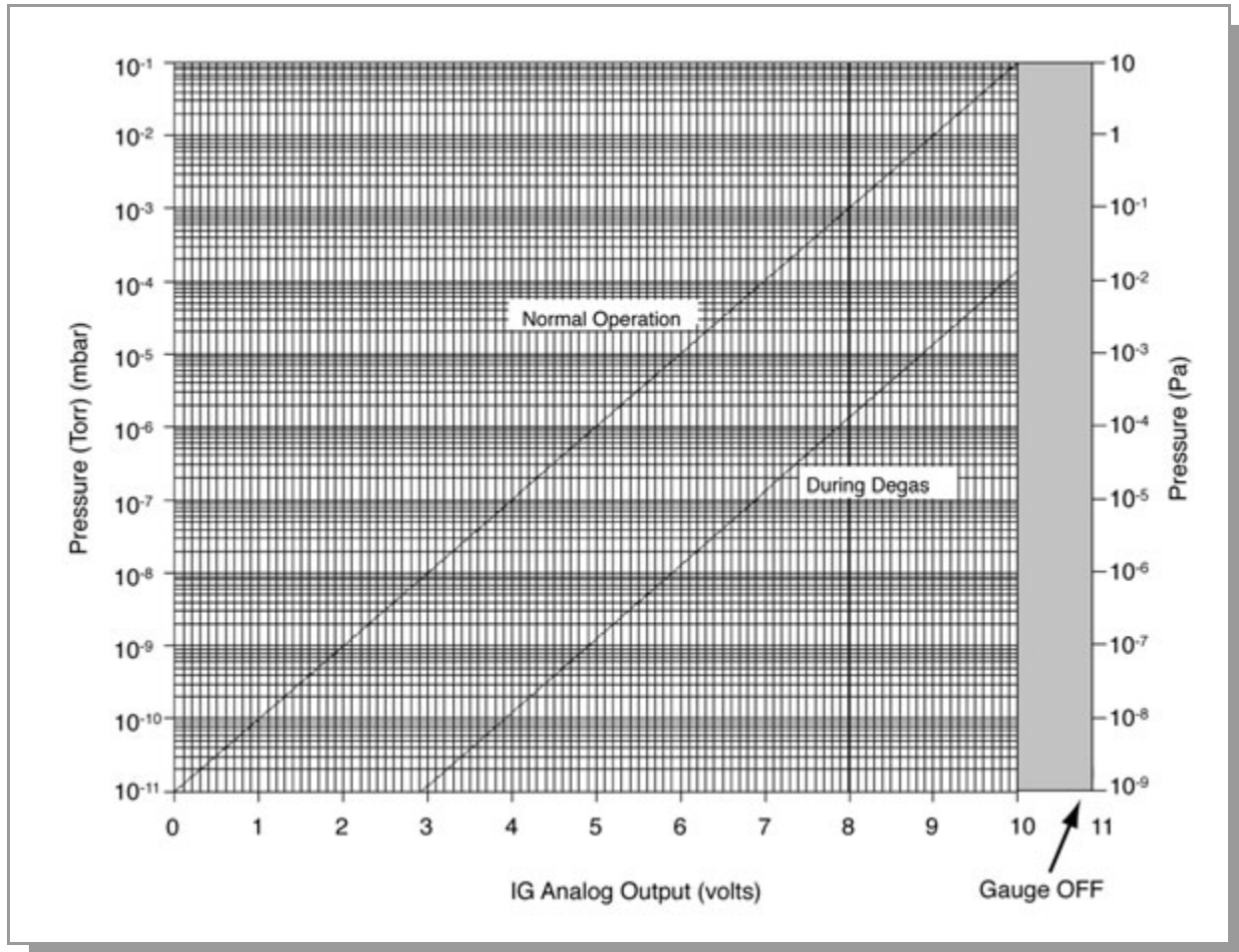

Figure 4-4 Ionization Gauge Analog Output vs. Pressure.

4.3 Preparing for Convector Gauge Operation

Convector Gauge pressures are indicated on lines A and B of the Controller display.



Using the N₂ calibration to pressurize a vacuum system above about 1 Torr with certain other gases can cause dangerously high pressures which may cause explosion of the system. See Section 4.3.1 on page 4-4 before using with other gases.

Install suitable devices that will limit the pressure to the level that the vacuum system can safely withstand. In addition, install suitable pressure relief valves or rupture disks that will release pressure at a level considerably below that pressure which the system can safely withstand.

Suppliers of pressure relief valves and pressure relief disks are listed in the Thomas Register under "Valves, Relief", and "Discs, Rupture."

Confirm that these safety devices are properly installed before installing the product. In addition, check that (1) the proper gas cylinders are installed, (2) gas cylinder valve positions are correct on manual systems, and (3) the automation is correct on automated systems.

Vacuum gauges with compression fittings may be forcefully ejected if the vacuum system is pressurized.

4.3.1 Understanding Pressure Measurement in Gases other than Nitrogen (or Air)

Convectron Gauges are thermal conductivity gauges of the Pirani type. These gauges transduce gas pressure by measuring the heat loss from a heated sensor wire maintained at constant temperature. For different gases, the heat loss is different at any given true pressure and thus the pressure indication can be very different.

It is important to understand that the indicated pressure of a Convectron Gauge depends on the type of gas, the orientation of the gauge axis, and on the gas density in the gauge. Convectron Gauges are normally supplied calibrated for N₂ (air has approximately the same calibration). With proper precautions, the Convectron Gauge may be used to measure pressure of certain other gases.

The following information in this section applies only when the Convectron Gauge has been calibrated for N₂ and when the Convectron Gauge is mounted with its axis horizontal. It does not apply when a Convectron Gauge's memory has been reprogrammed for a specific gas other than N₂.

At pressures below a few Torr, there is no danger in measuring pressure of gases other than N₂ and air, merely inaccurate indications. A danger arises if the N₂ calibration is used without correction to measure higher pressures of some other gases. For example, N₂ or air at 24 Torr causes the same heat loss from the Convectron sensor as will argon at atmospheric pressure. Thus if the pressure indication of the Convectron Gauge is not properly corrected for argon, an operator attempting to fill a vacuum system with 1/2 atmosphere of argon would observe an indication of only 12 Torr when the actual pressure had risen to the desired 380 Torr. Continuing to fill the system with argon to 760 Torr would result in only a 24 Torr indication. Depending on the pressure of the argon gas source, the chamber could be dangerously pressurized while the display continued to read about 30 Torr of N₂ equivalent pressure.

NOTE: The same type of danger likely exists with other thermal conductivity gauges utilizing convection to extend the range to high pressures; and with Convectron Gauges calibrated for gas type Y when used with gas type X.

Understand that, with a Convectron Gauge calibrated for N₂, to measure the pressure of gases other than N₂ and air you must use the conversion curves specifically for the Convectron Gauge to translate between indicated pressure and true pressure. Do not use other data. Never use conversion curves for the Convectron Gauge with gauges of other manufacturers. Their geometry is very likely different and dangerously high pressures may be produced even at relatively low pressure indications. **Also, you must ensure that the atmosphere adjustments for Convectron Gauges A and B are correctly set. See Section 4.5 on page 4-14.**

Figures 4-5 through 4-10 show the true pressure vs. indicated pressure for eleven commonly used gases. The following list will help to locate the proper graph:

Table 4-1 Pressure vs. Indicated N_2 Pressure Curve.

Fig. No.	Pressure Range and Units	Gases
4-5	10^{-4} to 10^{-1} Torr	All
4-6	10^{-1} to 1000 Torr	Ar, CO_2 , CH_4 , Freon 12, He
4-7	10^{-1} to 1000 Torr	D_2 , Freon 22, Kr, Ne, O_2
4-8	10^{-4} to 10^{-1} mbar	All
4-9	10^{-1} to 1000 mbar	Ar, CO_2 , CH_4 , Freon 12, He
4-10	10^{-1} to 1000 mbar	D_2 , Freon 22, Kr, He, O_2

Note that 1 mbar = 100 Pa, so the mbar charts may be used for pascal units by multiplying the values on the axes by 100.

A useful interpretation of these curves is, for example, that at a true pressure of 2×10^{-2} Torr of CH_4 the heat loss from the sensor is the same as at a true pressure of 3×10^{-2} of N_2 (see Figure 4-5 on page 4-7). The curves at higher pressure vary widely from gas to gas because the thermal losses at higher pressures are greatly different for different gases.

If you must measure the pressure of gases other than N_2 or air, use Figures 4-5 through 4-10 to determine the maximum safe indicated pressure for the other gas as explained below.

4.3.2 Examples

Example 1 – *Maximum safe indicated pressure.*

Assume a certain system will withstand an internal pressure of 2000 Torr or 38.7 psia. For safety, you wish to limit the maximum internal pressure to 760 Torr during backfilling. Assume you wish to measure the pressure of Freon 22. On Figure 4-7 on page 4-9, locate 760 Torr on the left hand scale, travel to the right to the intersection with the Freon 22 curve, and then down to an indicated pressure of 11 Torr (N₂ equivalent). Thus, in this hypothetical situation, the maximum safe indicated pressure for Freon 22 is 11 Torr.

For the sake of safety, it is prudent to place a warning label on the instrument face which under the assumed conditions would read "DO NOT EXCEED 11 TORR FOR FREON 22".

If the Convectron Gauge calibration is for a gas type other than N₂ (or air), we suggest placing a label near the second and third lines of the display indicating the gas type or types used for calibration to prevent mix-ups.

Example 2 – *Indicated to true pressure conversion.*

Assume you wish to determine the true pressure of helium in a system when the Convectron is indicating 10 Torr. On Figure 4-6 on page 4-8, read up from 10 Torr (N₂ equivalent) indicated pressure to the Helium curve and then horizontally to the left to a true pressure of 4.5 Torr. Thus 4.5 Torr Helium pressure produces an indication of 10 Torr (N₂ equivalent).

Example 3 – *True to indicated pressure conversion.*

Assume you wish to set a process control setpoint at a true pressure of 20 Torr of CO₂. On Figure 4-6 on page 4-8, locate 20 Torr on the true pressure scale, travel horizontally to the right to the CO₂ curve and then down to an indicated pressure of 6.4 Torr (N₂ equivalent). Thus the correct process control setting for 20 Torr of CO₂ is 6.4 Torr (N₂ equivalent).

Example 4 – *True to indicated pressure conversion.*

Assume you wish to obtain a helium pressure of 100 Torr in the system. On Figure 4-6 on page 4-8, locate 100 Torr on the left hand scale, travel horizontally to the right to attempt to intersect the He curve. Because the intersection is off scale, it is apparent that this true pressure measurement requirement for helium exceeds the capability of the instrument.

For gases other than those listed, the user must provide accurate conversion data for safe operation. The Convectron Gauge is not intended for use above approximately 1000 Torr true pressure.

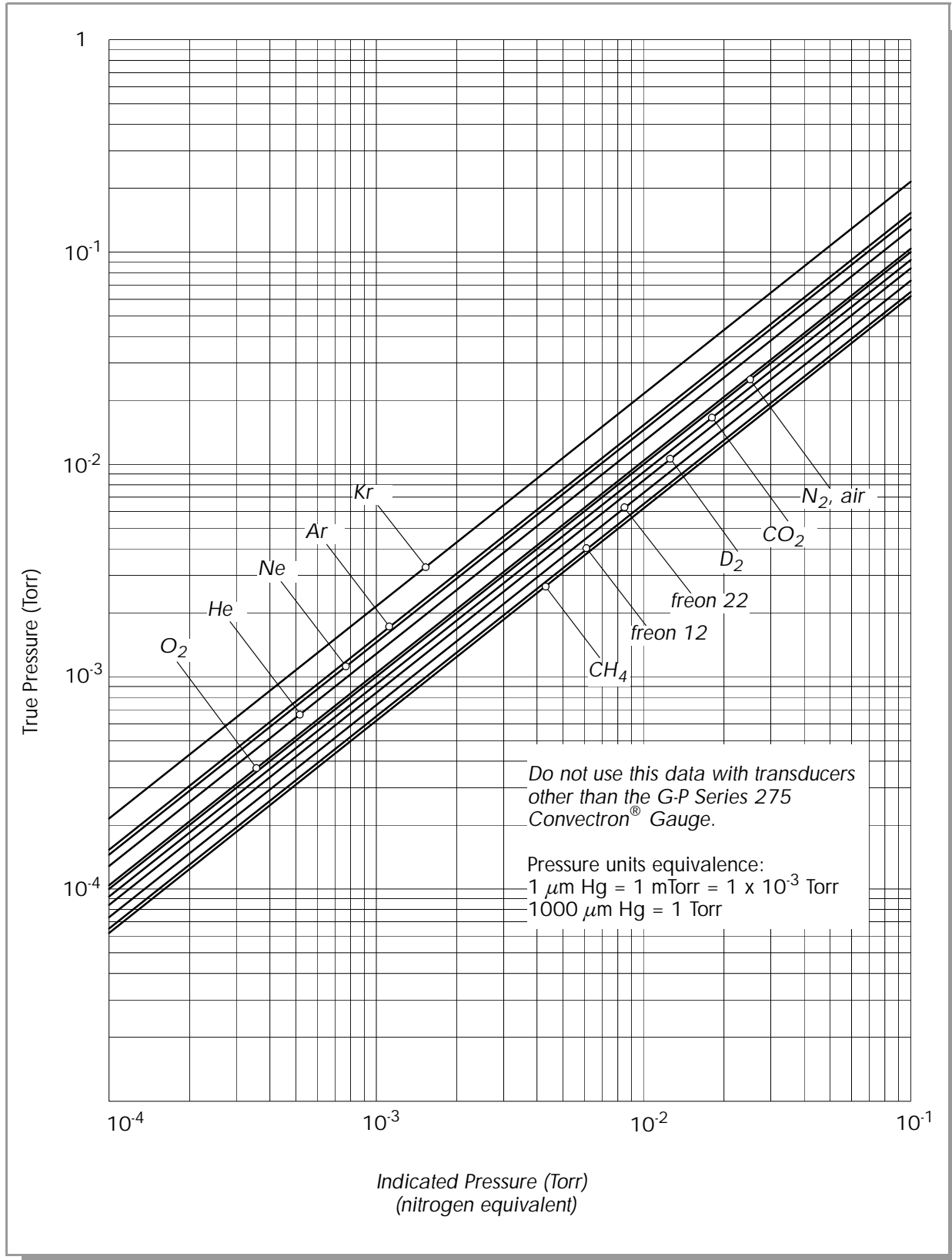

Figure 4-5 Convectron Gauge Indicated vs. True Pressure Curve; 10^{-4} to 10^{-1} Torr.

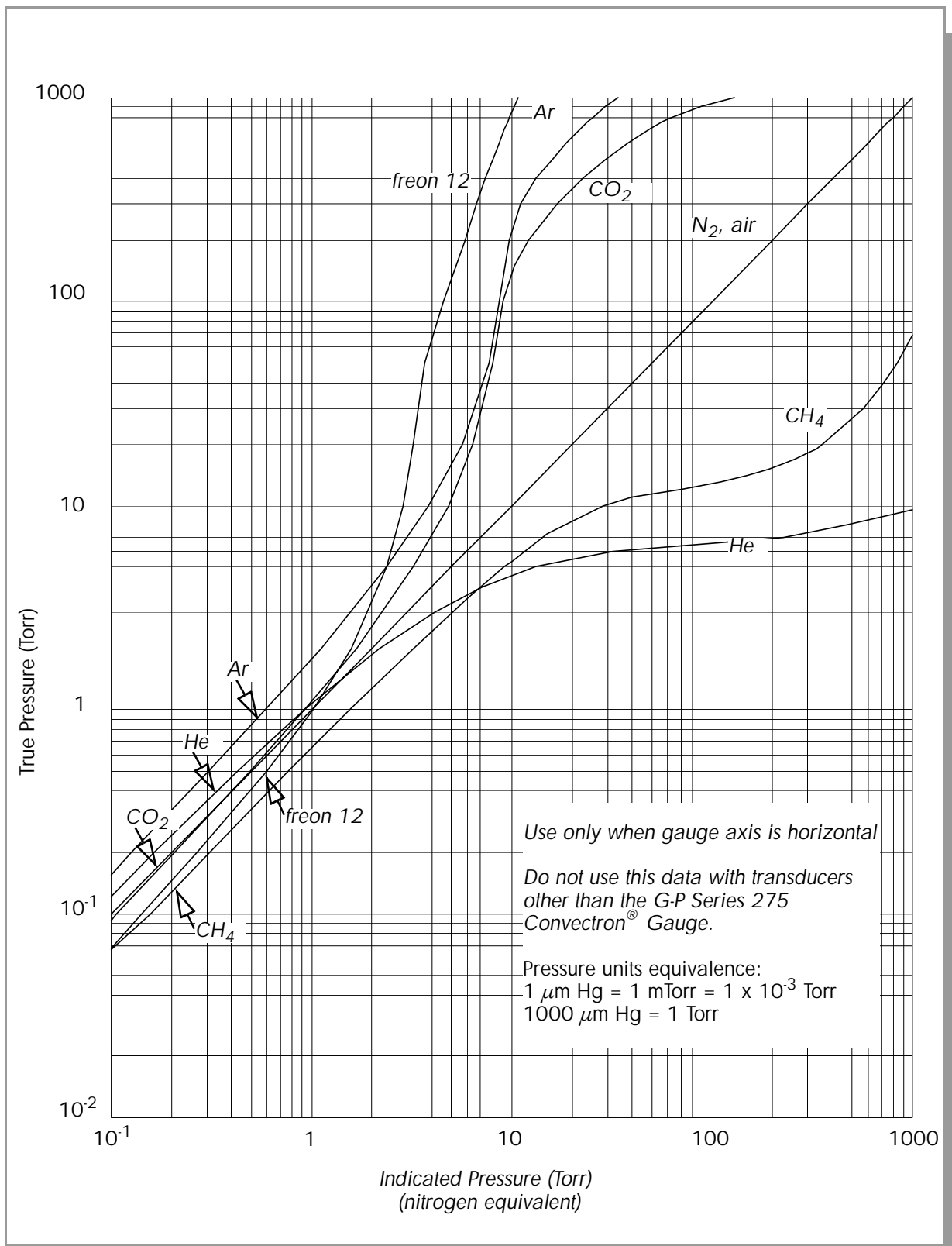

Figure 4-6 Convectron Gauge Indicated vs. True Pressure Curve; 10^{-1} to 1000 Torr.

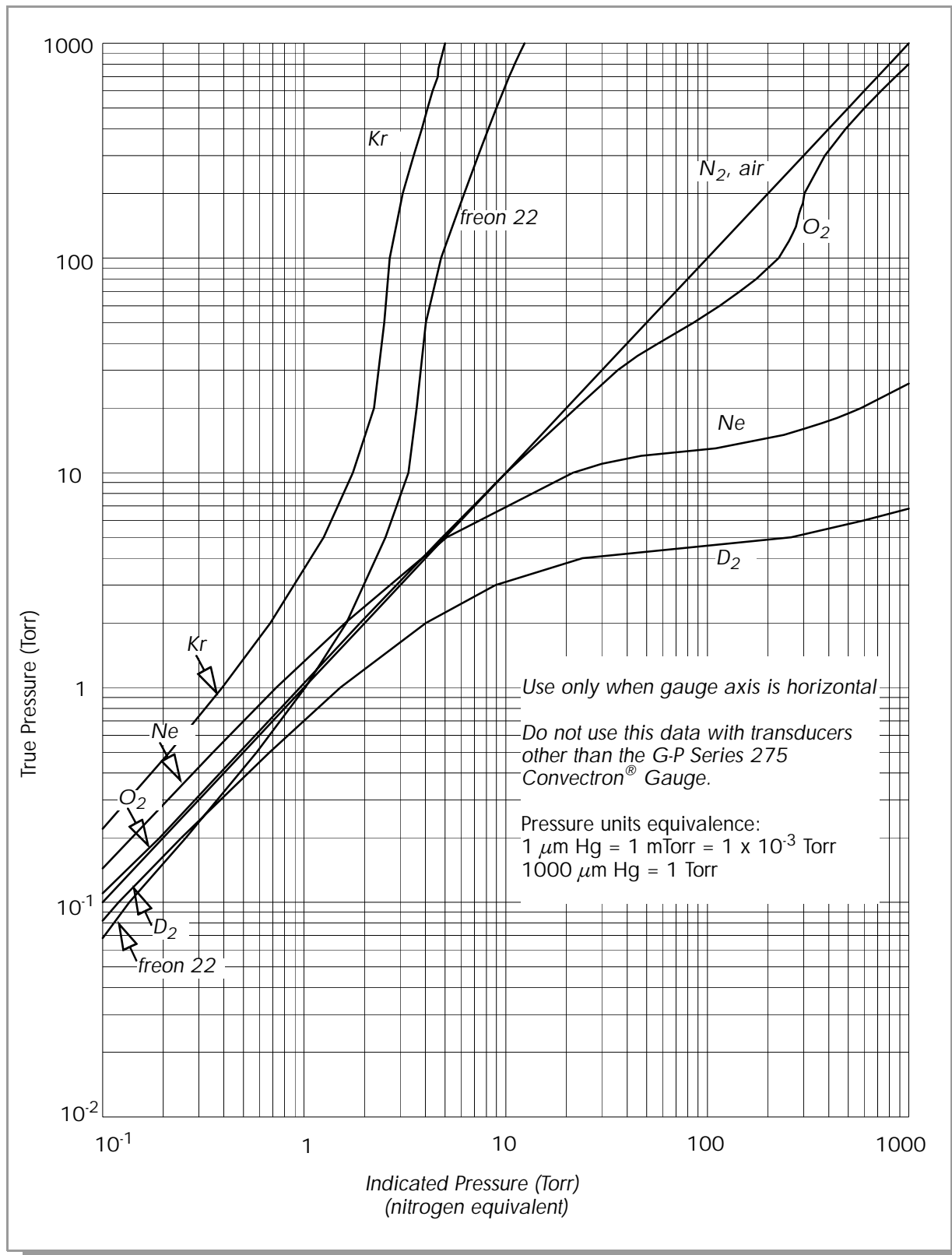

Figure 4-7 Convectron Gauge Indicated vs. True Pressure Curve; 10^{-1} to 1000 Torr.

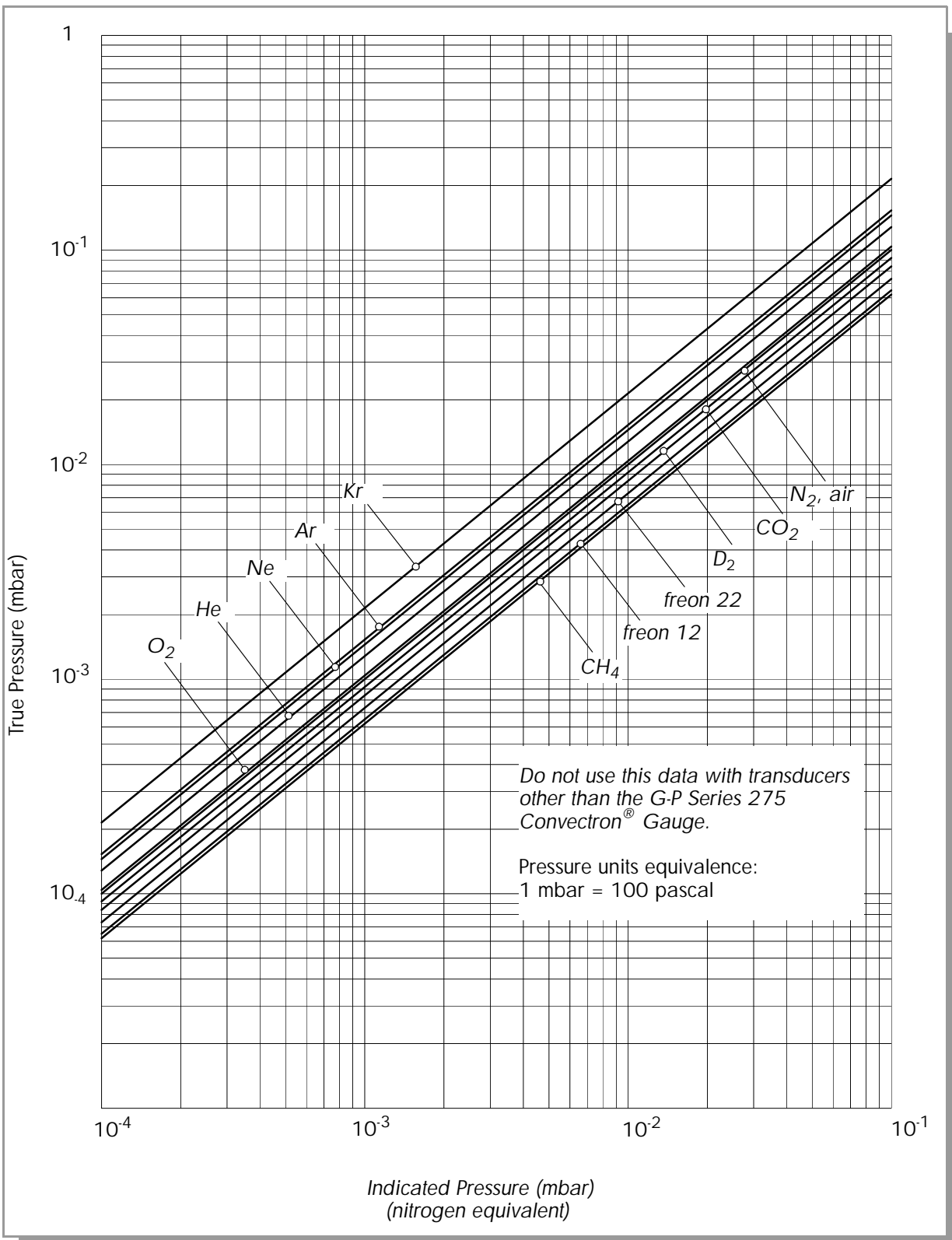

Figure 4-8 Convectron Gauge Indicated vs. True Pressure Curve; 10^{-4} to 10^{-1} mbar.

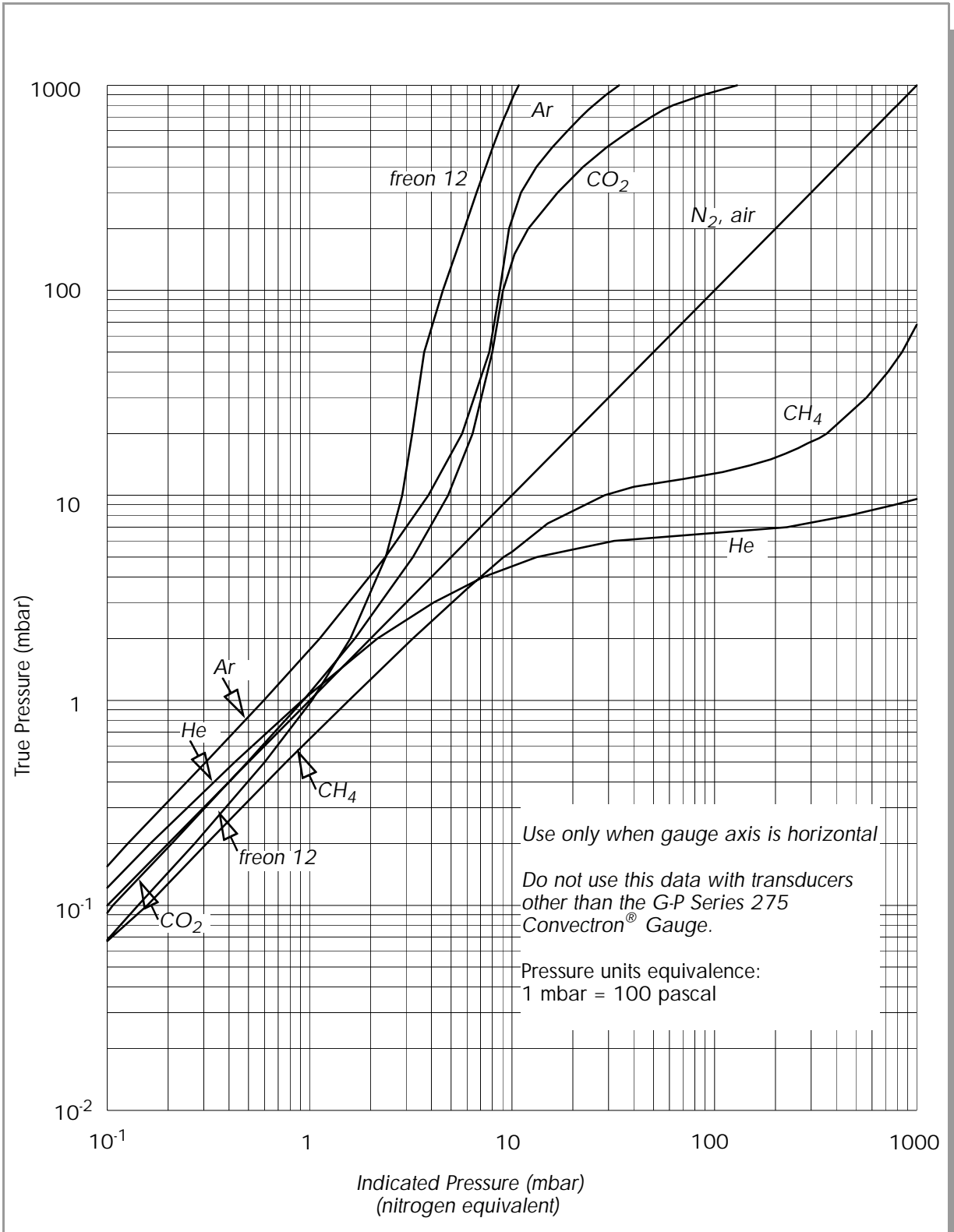

Figure 4-9 Convectron Gauge Indicated vs. True Pressure Curve; 10^{-1} to 1000 mbar.

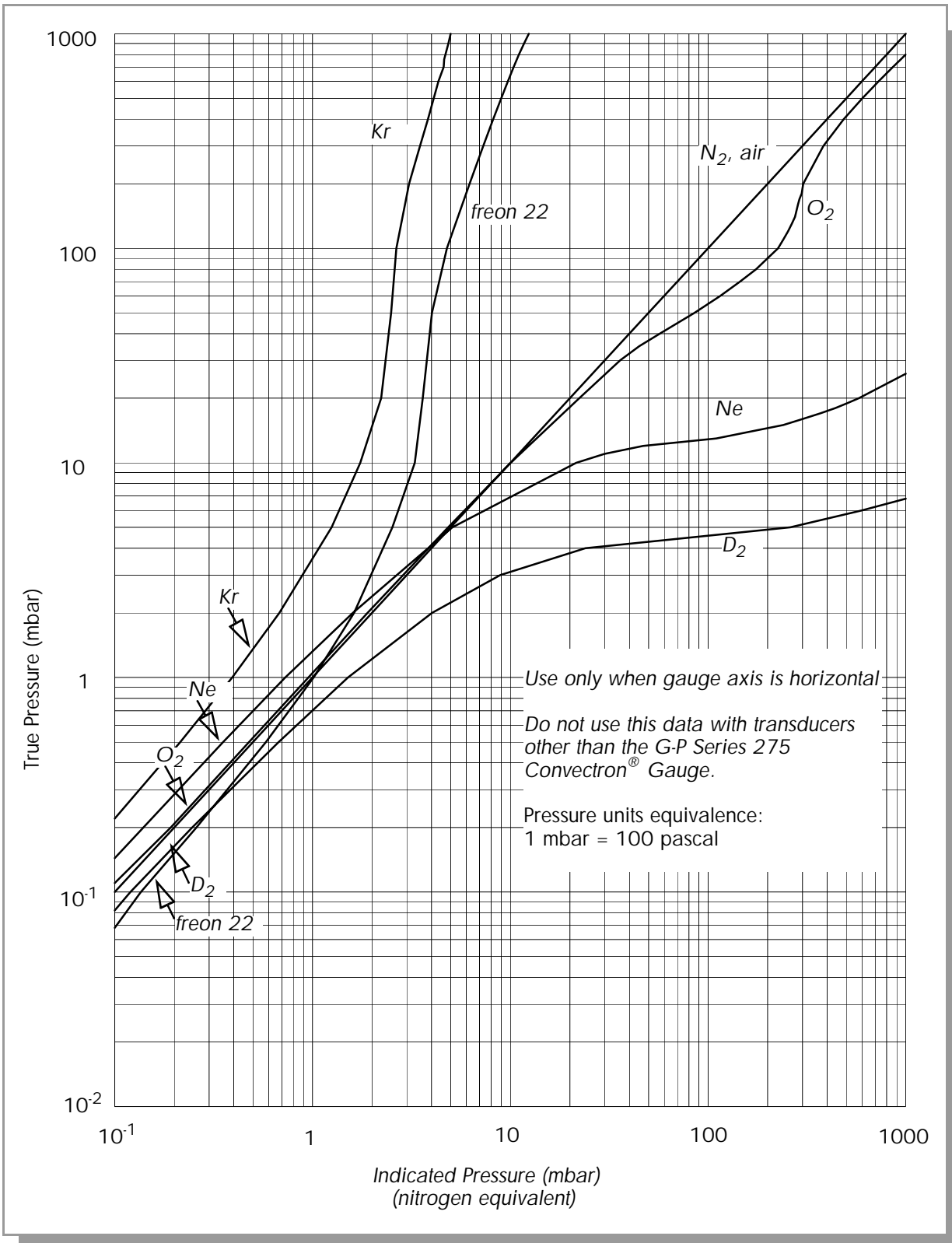

Figure 4-10 Convectron Gauge Indicated vs. True Pressure Curve; 10^{-1} to 1000 mbar.

4.4 Ionization Gauge Auto Turn On/Off



Warning – If used improperly, Convectron Gauges can supply misleading pressure indications that can result in dangerous overpressure conditions within the system. For use with gases other than air or N₂, consult the gas type correction charts in Section 4.3.1 on page 4-4.

If a Convectron Gauge is exposed to the same pressure environment as a Micro-Ion Gauge, then the Convectron Gauge may be used to automatically turn on the IG. Convectron Gauge A can turn on IG1 and Convectron Gauge B can turn on IG2. Micro-Ion Gauge automatic turn-on occurs when the Convectron Gauge pressure drops below the auto turn-on setpoint defined by the auto turn-on setting. The Micro-Ion Gauge will also be turned off automatically when the pressure rises slightly above the auto turn-on setpoint if the electrometer overpressure setpoint does not trip first.

The automatic on/off function will execute only once per setpoint crossing. For example, if the IG is turned off manually when below the setpoint, the auto-on function will not turn it back on until the Convectron Gauge pressure has risen above the setpoint and then dropped below it again.

4.4.1 Filament Auto Turn-On

1. Place the IG Auto switch on the Convectron Gauge module in the Set position.
2. The existing turn on pressure is displayed on the A display.
3. Set the desired turn on pressure with the Auto Set adjustment.
4. To deactivate this capability place the IG Auto switch in the Off position.

Do not leave the switch in the Set position, as this prevents pressure from being displayed.

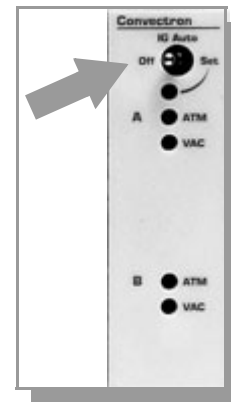

Figure 4-11 Convectron Gauge Module IG Auto Switch.

4.5 Adjustment of Convectron Gauge Zero and Atmospheric Pressure Indications



Using the N₂ calibration to pressurize a vacuum system above about 1 Torr with certain other gases can cause dangerously high pressures which may cause explosion of the system. See Section 4.3.1 on page 4-4 before using with other gases.

Each Convectron Gauge is individually computer-calibrated for N₂. Adjustment of the zero should not be necessary unless readout accuracy is required below 1×10^{-3} Torr. Adjustment of the atmospheric indication should not be necessary unless compensating for long cables or variations in mounting orientation. The Convectron Gauge has a stable, temperature compensated design and each Controller is also calibrated to provide accurate readout of N₂ pressure with any gauge when properly installed with the gauge axis horizontal.

1. Evacuate Convectron Gauge A to a pressure known to be less than 1×10^{-4} Torr.
2. With power on and at vacuum less than 1×10^{-4} Torr for at least 15 minutes, adjust VAC for gauge A (see Figure 4-12) until display A indicates 0.0 0 Torr/mbar or 0.0 0 Pa, not 1.0 -4, 1.0 -2, or 0.0 -0.
3. Let the pressure in the gauge increase to the local atmospheric pressure.
4. Read the local atmospheric pressure on an accurate barometer nearby.
5. With the power on, adjust ATM adjustment A until display A indicates the local atmospheric pressure in the pressure units you have selected.

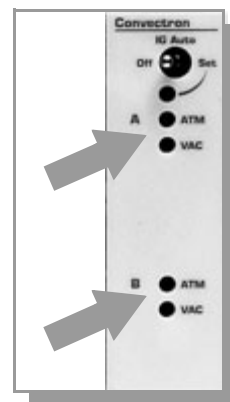

Figure 4-12 Convectron Gauge Zero and Atmospheric Adjustments.

6. Repeat the above steps for Convectron Gauge B.

NOTE: 1 atmosphere normal at sea level = $7.6 \times 10^{+2}$ Torr = $1.0 \times 10^{+3}$ mbar = $1.0 \times 10^{+5}$ Pa.

4.6 Convectron Gauge Analog Output Signal

If the Convectron Gauge capability is installed, a voltage output signal proportional to the common logarithm of the pressure indication is provided on the rear panel of the Convectron Gauge module via a standard 1/8 in. miniature phono jack.

If graphed on log-linear axes, the output voltage is linear with respect to the log of pressure. The analog output is 1 volt per decade of pressure with a factory adjusted output of 0 volts at 1.0×10^{-4} Torr.

Offset adjustments are provided on the top edge of the Convectron Gauge module that allow shifting the voltage corresponding to 1×10^{-4} Torr between -7 volts and +1 volt.

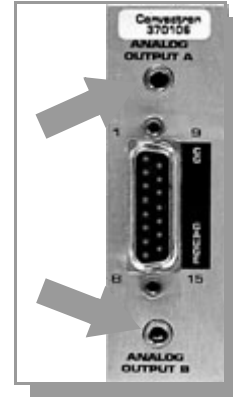

Figure 4-13 Convectron Gauge Module, Rear Panel.

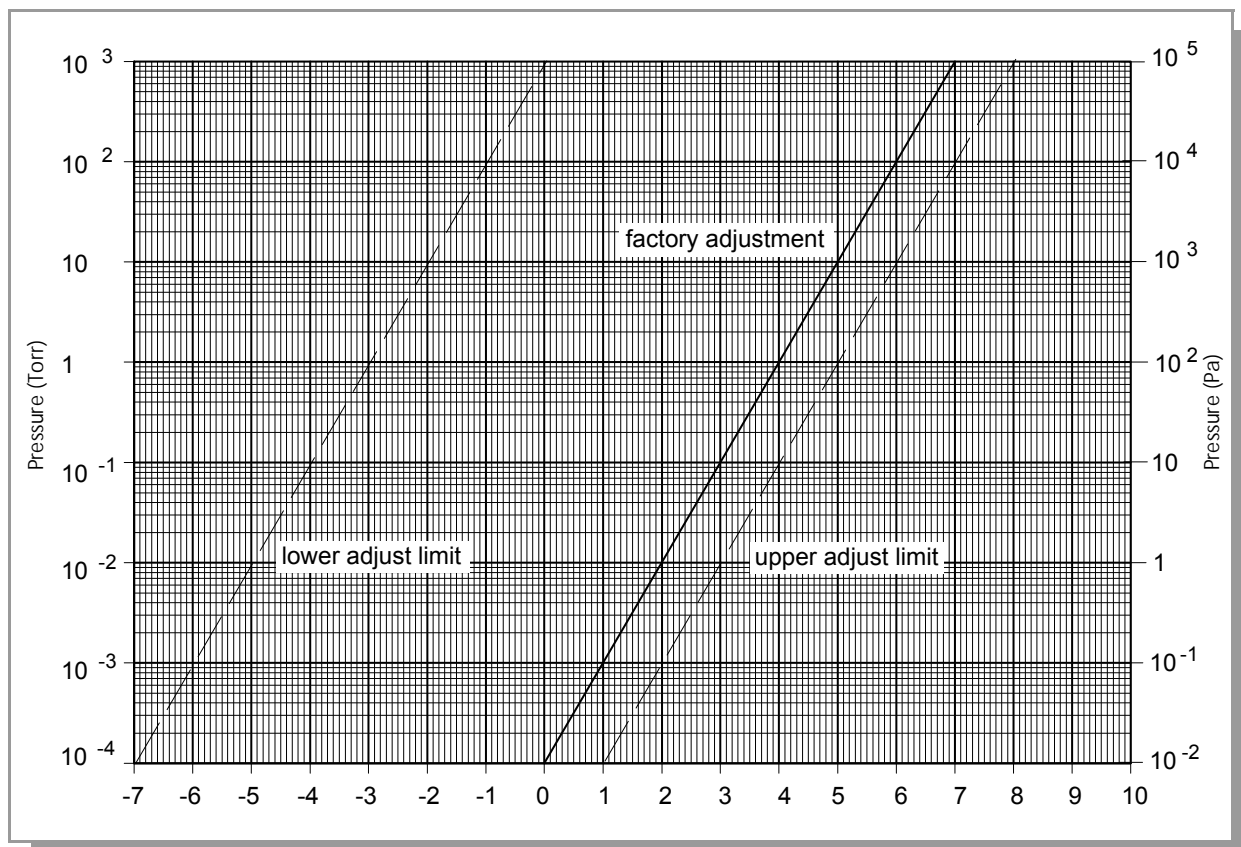

Figure 4-14 Convectron Gauge Analog Output vs. Pressure.

The voltage signal is smooth and continuous throughout all the decades of pressure measurement. This format is useful for computerized data acquisition because a simple equation (finding the common antilogarithm) may be programmed to calculate pressure from the voltage output.

The equation is: $P_i = 10^{V-4}$ Torr/mbar, or $P_i = 10^{V-2}$ Pascal

where P_i = pressure indication,
 V = analog output voltage

and: the offset is at the factory adjusted 0V at 10^{-4} Torr (10^{-2} Pa).

If the offset has been adjusted to other than 0V at 10^{-4} Torr (10^{-2} Pa), then the exponent value must be forced to -4 (-2 for Pa) when the pressure is at 1.0×10^{-4} Torr (10^{-2} Pa) by adding or subtracting a number other than -4 from the value of V.

For example, if the offset has been adjusted so that the output voltage is -7 V at 10^{-4} Torr (10^{-2} Pa), then +3 (+5 for Pa) must be used in the equation instead of -4, i.e., $P = 10^{(-7+3)}$. Furthermore for the same offset, if the pressure were, say, 10^{-2} Torr, then the output voltage would be -5V. The pressure would be calculated as $P = 10^{(-5+3)}$.

4.7 Preparing for Process Control Operation

4.7.1 Setpoint Display and Adjustment

Setpoints are stored in non-volatile memory, and are specified by a 2-digit mantissa and 2-digit exponent. They may be set anywhere in the range 1×10^{-12} to $9 \times 10^{+5}$. This allows for the entire pressure range of all supported transducer types and systems of units.

The setpoint is compared directly to the display data, so units of measure are implicit. Changing the units switch on the gauge control modules will not change the stored setpoints. They must be re-programmed in the new system of units.

There is a programmed 10% hysteresis on each Process Control setpoint. For example, with a pressure setpoint of 6.3×10^{-6} Torr the relay will activate when the display reaches 6.2×10^{-6} Torr (for falling pressure) and will de-activate when the pressure rises to one significant digit above the setpoint plus 10%, i.e., $6.3 \times 10^{-6} + 0.6 \times 10^{-6} + 0.1 \times 10^{-6}$ or 7.0×10^{-6} Torr. For setpoints where the 2nd digit is 0.5 or greater the 10% value is rounded up. For example, if the setpoint is programmed to 6.6×10^{-6} Torr the relay will activate at 6.5×10^{-6} Torr (on falling pressure) and will de-activate when the pressure rises to $6.6 \times 10^{-6} + 0.7 \times 10^{-6} + 0.1 \times 10^{-6}$ or 7.4×10^{-6} Torr.

Since the Process Control and computer interface modules derive their pressure data directly from the display bus, they will be unable to update their pressure data while setpoints are being displayed. They will not mistakenly interpret setpoint data as pressure data, but will simply retain the last displayed pressure data until the SET key is released.

4.7.2 Manual Override

The three-position switches on the front of the Process Control module allow override of the programmed setpoints at any time. When moved to the right, the relay is activated. When moved to the left, the relay is de-activated. When left in the center position, the relay is controlled automatically.

4.7.3 To Display a Setpoint

1. Be sure the "CAL" switch of the Electrometer module is in its center position, or the calibration data in display line 1 will conflict with the display of setpoints 1 and 2.
2. Set selector switch 1 to the number of the channel you wish to display.
3. Press the setpoint display/set button to either the Up or Down position and release. The setpoint will appear for 2 seconds in the corresponding display.

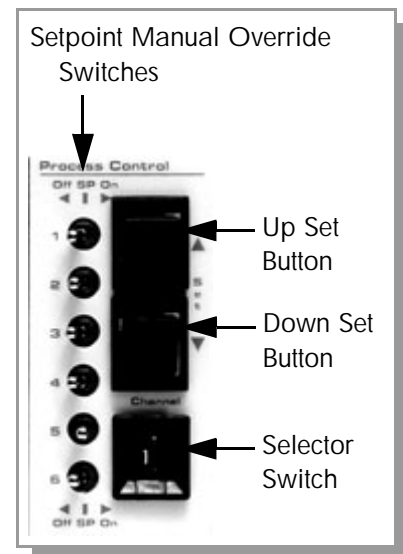

Figure 4-15 Process Control Module, Front Panel.

4.7.4 To Modify a Setpoint

1. Set the selector switch to the number of the channel you wish to modify (see Figure 4-15).
2. Press and hold one of the setpoint Set pushbuttons for the direction you wish the setpoint to change.
3. The setpoint will scroll until the switch is released. It will scroll slowly until a decade boundary is crossed and then will speed up to facilitate rapid changes across many decades. Release the switch when you have entered the desired decade, and then re-depress it to scroll slowly within the decade to reach the exact setpoint needed.

After the setpoint switch is released, the display will return to pressure data after two seconds. At this time the new setpoint will be deposited in non-volatile memory.

NOTE: If the ion gauge is off, PC relays 1 and 2 will de-activate.

4.8 Preparing for Use of the RS-232 Computer Interface

Consult the user's manual for the host computer to be sure the protocol used is in accord with that established via the switch configuration you have chosen for the 358 RS-232 module.

Communication with the 358 VGC is via ASCII strings. A message to the 358 consists of a command and a command modifier, followed by a terminator. The message may contain leading spaces, and the command and modifier may optionally be separated by spaces or commas. No spaces may appear within the command or the modifier, only between them.

The terminator expected by the 358 is an ASCII carriage-return and line-feed, denoted here by CRLF. A carriage return, code CR, is hex 0D or decimal 13. A line feed, code LF, is hex 0A or decimal 10. The carriage-return is optional, and messages terminated with only the line-feed will be accepted. Note that the CRLF terminator is, in general, appended automatically by the host computer's interface software to the message string supplied by the user.

If extra characters are found in the message after it has been successfully interpreted but before the terminator, they will be ignored.

All characters should be upper-case.

All messages to the 358 will receive a reply, consisting of an ASCII string terminated with CRLF. Numbers will be returned in the format X.XXE±XX.

4.8.1 Command Syntax for the RS-232 Computer Interface

DG

Definition: Turn degas on or off.

Modifiers: **ON** or **OFF**

Response: **OK** if command accepted, or **INVALID** if rejected.

Example: From computer: **DG ON CRLF**
From 358: **OKCRLF**

NOTES

1. Command is **INVALID** if neither IG is on.
2. A response to the DG ON command of **OK** indicates only that a signal requesting degas has been sent to the electrometer. Degas may fail to activate if the pressure is above 5×10^{-5} Torr. Use the DGS command (see below) to verify that degas has been successfully initiated.

DGS

Definition: Display degas status.
Modifiers: None
Response: ASCII **1** if degas is on, **0** if degas is off.
Example: From computer: **DGS CRLF** (**Note:** Spaces may be omitted.)
From 358: **1CRLF**
(Indicating degas is on.)

DS

Definition: Display pressure reading.
Modifiers: **IG1** or **IG2** or **IG** or **CG1** or **CG2**.
Response: ASCII string representing the pressure for the selected gauge.
Example: From computer: **DS IG CRLF**
Hex notation: 44 53 20 49 47 0D 0A
From 358: **1.20E-07CRLF**
Hex notation: 31 2E 32 30 45 2D 30 37 0D 0A

NOTES

1. The **DS IG** command will return pressure from the top display if either filament is on, and **9.90E+09** if neither is on.
2. The **DS CG1** command will return pressure from the middle display.
3. The **DS CG2** command will return pressure from the bottom display.

IG1

Definition: Turn IG1 filament on or off.
Modifiers: **ON** or **OFF**
Response: **OK** if command accepted, **INVALID** if rejected.
Example: From computer: **IG1 ON CRLF**
From 358: **OKCRLF**

NOTES

1. The **IG1 ON** command will be rejected as **INVALID** if Filament 1 is already on, and **IG1 OFF** will be rejected if Filament 1 is already off.
2. A response to the **IG1 ON** command of **OK** indicates only that a signal requesting that Filament 1 be turned on has been sent to the electrometer. The tube may fail to come on, e.g., if the system pressure is too high or if the tube is disconnected. If the tube is off (or in its first few seconds of operation after being turned on), a pressure of **9.99E+9** will be returned.

IG2

Identical to **IG1**, but applies to Filament 2.

PCS

Definition: Display process control channel status.
Modifiers: **1** or **2** or **3** or **4** or **5** or **6** or **B** or none.
Response: Depends on modifier:

Modifier = single digit (1 through 6); response = single ASCII digit, **0** if the corresponding relay is inactive, **1** if active. See Example 1.

Modifier = **B**; response = a byte of data with bits 0 through 5 set/clear according to whether the corresponding relay is active/inactive. Bit 6 will always be set to guarantee that the returned byte will not appear as a terminator byte. See Example 2.

Modifier absent; response will be a string of 6 ASCII 0's and 1's separated by commas giving the status of all six channels. See Example 3.

Examples: Assume that channels 1 - 3 are active, and 4 - 6 are inactive:

1. From computer: **PCS 1 CRLF**

From 358: **1CRLF**

2. From computer: **PCS B CRLF**

From 358: **GCRLF**

(Note that ASCII "G" corresponds to the bit pattern 01000111 and represents the status of the PC channels in bits 0 through 5).

3. From computer: **PCS CRLF**

From 358: **1,1,1,0,0,0 CRLF**

Error Messages

If an error is found in the incoming message, the following messages will be returned in place of the normal response:

OVERRUN ERROR Returned if the incoming message overflows the 358's buffer. This may indicate a flaw in the host software.

PARITY ERROR Returned if the parity of a byte in the incoming message does not match that programmed by the switches.

SYNTAX ERROR Returned if the message fails to parse as a valid 358 command. Could also result from failure to assert DCD during transmission to the 358.

4.9 Preparing for Use of the RS-485 Computer Interface

Consult the user's manual for the host computer to be sure the protocol used is in accord with that established via the switch configuration you have chosen for the RS-485 module.

Communication is via ASCII strings. A message to consists of a start character "#", an address, a command, and a command modifier, followed by a terminator. The message may contain leading spaces, and the command and modifier may optionally be separated by spaces or commas. No spaces may appear within the command or the modifier, only between them.

The address expected is programmed via the switch settings on the rear of the module. The syntax is "#AA" where AA is an ASCII representation of the hex address of the VGC.

The terminator expected is an ASCII carriage-return denoted here by CR. Note that the terminator is sometimes appended automatically, by the host computer's interface software, to the message string supplied by the user. If extra characters are found in the message after it has been successfully interpreted but before the terminator, they will be ignored.

All messages will receive a reply, consisting of an ASCII string terminated with CR. Numbers will be returned in the format X.XXE±XX.

Messages may use upper or lower case alpha characters. The VGC will always respond with upper case characters.

4.9.1 Command Syntax for the RS-485 Computer Interface

DG

Definition: Turn degas on or off.
Modifiers: **ON** or **OFF**.
Response: **OK** if command accepted, or **INVALID** if rejected.
Example: From computer: **#AADG ON CR**
From 358: **OKCR**

NOTES:

1. Command is **INVALID** if IG is **OFF**.
2. A response to the **DG ON** command of **OK** indicates only that a signal requesting degas has been sent to the electrometer. Degas may fail to activate, e.g., if the pressure is above 5×10^{-5} Torr. Use the **DGS** command (see below) to verify that degas has been successfully initiated.

DGS

Definition: Display degas status.
Modifiers: None.
Response: ASCII **1** if degas is on, **0** if degas is off.
Example: From computer: **#AADGSCR** (**Note:** Spaces may be omitted).
From 358: **1CR**
(Indicating degas is on)

DS

Definition: Display pressure reading.
Modifiers: **IG1** or **CG1** or **CG2**
Response: ASCII string representing the pressure for the selected gauge.
Example: From computer: **#AADS CG1 CR**
From 358: **1.20E-03CR**

NOTES:

1. The **DS CG1** and **DS CG2** commands are used to display the pressures from the second and third display lines.
2. If the ion gauge is turned off, or is in its first few seconds of operation, the 358 will return **9.90E+09**.
3. The **DS IG** command will return pressure if the gauge is on, and **9.90E+09** if it is **OFF**.

IG1

Definition: Turn IG1 on or off.
Modifiers: **ON** or **OFF**
Response: **OK** is command accepted, **INVALID** if rejected.
Example: From computer: **#AAIG1 ON CR**
From 358: **OKCR**

NOTES:

1. The **IG1 ON** command will be rejected as **INVALID** if IG1 is already on, and **IG1 OFF** will be rejected if IG1 is already off.
2. A response to the **IG1 ON** command of **OK** indicates only that a signal requesting that IG1 be turned on has been sent to the electrometer. The tube may fail to come on, e.g., if the system pressure is too high or if the tube is disconnected. To verify that IG1 is on, use the **DS IG1** command. If the tube is off (or in its first few seconds of operation after being turned on) a pressure of **9.90E+9** will be returned.

PCS

Definition: Display process control channel status

Modifiers: **1** or **2** or **3** or **4** or **5** or **6** or **B** or none.

Response: Depends on modifier:

Modifier = single digit (1 through 6); response = single ASCII digit, **0** if the corresponding relay is inactive, **1** if active.

Modifier - **B**; response = a byte of data with bit 0 through 5 set/clear according to whether the corresponding relay is active/inactive. Bit 6 will always be set to guarantee that the returned byte will not appear as a terminator byte.

Modifier absent; response will be a string of 6 ASCII 0's and 1's separated by commas giving the status of all six channels.

Examples: Assume that channels 1-3 are active, and 4-6 are inactive:

From computer: **#AAPCS 1 CR**

From 358: **1CR**

From computer: **#AAPCS B CR**

From 358: **GCR**

(Note that ASCII "G" corresponds to the bit pattern 01000111 and represents the status of the PC channels).

From computer: **#AAPCS CR**

From 358: **1,1,1,0,0,0CR**

Error Messages

If an error is found in the incoming message, the following messages will be returned in place of the normal response:

- | | |
|----------------------|--|
| OVERRUN ERROR | Returned if the incoming message overflows the buffer. This may indicate a flaw in the host software. |
| PARITY ERROR | Returned if the parity of a byte in the incoming message does not match that programmed by the switches. |
| SYNTAX ERROR | Returned if the message fails to parse as a valid command. |

NOTES

Operation

The instructions in this chapter assume the instructions for Setup, Installation, and Preparing for Operation have been completed. See Chapters 2, 3, and 4.

Theory of operation information for the Micro-Ion Gauge, Convectron Gauge, Electrometer, and Process Control modules begins on page 5-6.

5.1 Operation of the Series 358 Micro-Ion Vacuum Measurement System

5.1.1 Turning On the Controller

1. Press the top half of the power ON switch on the rear panel of the Controller (see Figure 5-5).

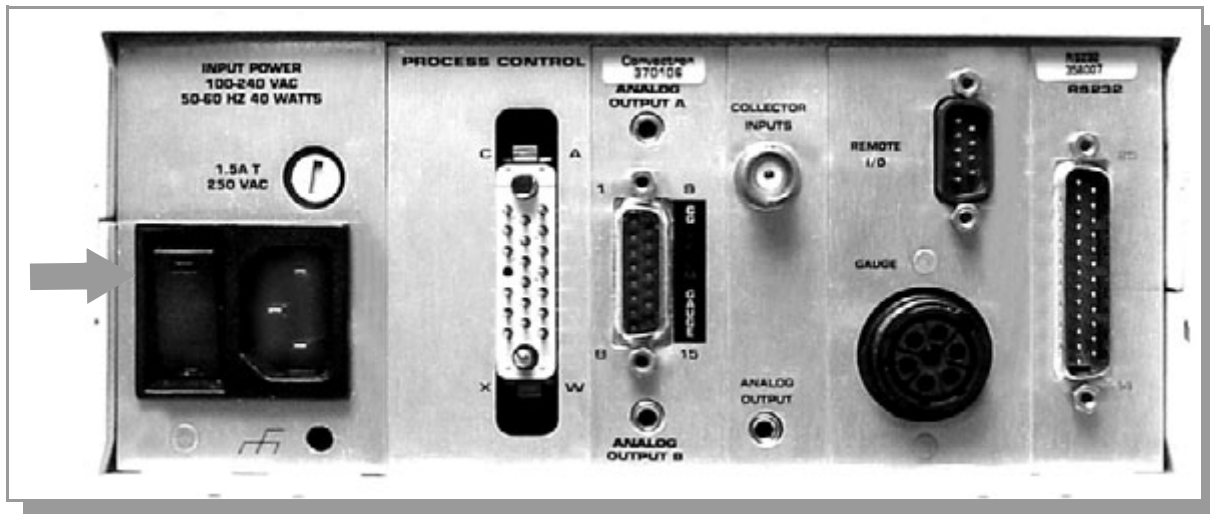

Figure 5-1 358 Controller Rear Panel Showing Power ON Button.

2. When the power switch is ON, the Micro-Ion Gauge pressure is displayed on line IG and Convectron Gauge pressures are displayed on lines A and B of the display on the front panel of the Controller (see Figure 5-2). Display formats for the Convectron Gauge pressures are given in Table 5-1 on page 5-2.

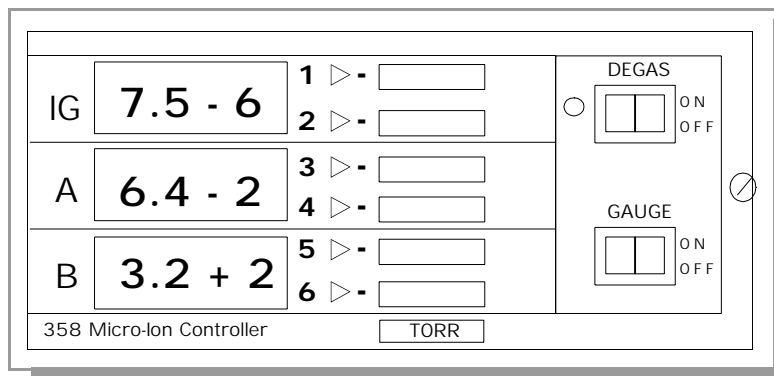

Figure 5-2 358 Controller Front Panel.

3. If you have Convecatron Gauge capability installed and have prepared your system for automatic operation of the Micro-Ion Gauge(s) per Section 4.4 on page 4-13, the ionization gauge will turn on and off automatically.
4. For manual operation, press the front panel GAUGE momentary rocker switch (see Figure 5-2 on page 5-1). The pressure in Micro-Ion Gauge will be displayed on the IG line of the display in the chosen pressure units.
5. To degas the IG (IG must be on and the pressure within IG must be below 5×10^{-5} Torr), depress the DEGAS momentary rocker switch on the Controller (see Figure 5-2 on page 5-1).
6. When the filament is nearing the end of its useful lifetime or is badly contaminated, the LED indicator next to the DEGAS switch on the front panel will blink during degassing (see Figure 5-2 on page 5-1). This is an indication that the filament emission properties have deteriorated. This may be due to contamination which has temporarily “poisoned” the filament coating, or to long term permanent erosion of the coating.
If this condition does not disappear after a few days of operation at clean high vacuum or UHV, it is an indication that the filament is approaching its end of life.
7. Stable pressure measurement requires that all the environmental parameters in, on, and around the vacuum gauge and vacuum system remain unchanged during measurement. Therefore, never attempt meaningful measurements immediately after turning on the Micro-Ion Gauge or immediately after degassing the gauge. Permit sufficient time for the environmental parameters to stabilize.

Table 5-1 Convecatron Gauge Display Formats.

Units	Display Format	Pressure	Example
torr	scientific	< 1 Torr	3.23–3 Torr
	floating point	> 1 Torr	7.15 Torr
mbar	scientific	< 1 mbar	5.18–2 mbar
	floating point	> 1 mbar	88.6 mbar
	scientific	> 999 mbar	1.23+3 mbar
pascal	scientific	< 1 Pa	7.23–1 Pa
	floating point	> 1 Pa	78.3 Pa
	scientific	> 999 Pa	1.25+4 Pa

5.1.2 Micro-Ion Gauge On/Off

The Micro-Ion Gauge can be turned on or off by the front panel GAUGE “momentary” rocker switch or by the remote input, or by the Convectron Gauge set point.

To turn on the Micro-Ion Gauge from the front panel, press the GAUGE momentary rocker switch (see Figure 5-2). To turn it OFF, press the GAUGE rocker switch again. After a 3-second delay, the Micro-Ion Gauge pressure will be displayed.

5.1.3 Degas On/Off

The EB (electron bombardment) degas may be turned on or off by the front panel DEGAS “momentary” rocker switch, (see Figure 5-2), or the remote input. To turn degas on, press the DEGAS momentary rocker switch. To turn it off, press the DEGAS momentary rocker switch again, or press the GAUGE momentary rocker switch to turn off DEGAS and turn on the gauge. Degas automatically turns off and returns to normal emission in 2 minutes.

Degas “ON” indication is by the degas LED adjacent to the DEGAS rocker switch on the front panel (see Figure 5-2). Degas cannot be activated unless the Micro-Ion Gauge has been turned ON and indicated system pressure is below 5×10^{-5} Torr. This prevents degas turn-on at pressures where emission can not be established or where degas is of no practical use. Micro-Ion Gauge pressure measurement is displayed during degas.

5.1.4 Special Considerations for Convectron Gauge Use Below 10^{-3} Torr

During a fast pumpdown from atmosphere, thermal effects will prevent the Convectron Gauge from tracking pressure accurately below 10^{-3} Torr. After about 15 minutes, indications in the 10^{-4} range will be valid and response will be rapid. Zero adjustment at vacuum may be performed at this time (or sooner if readings in the 10^{-4} range are not needed).

In the 10^{-4} Torr range, the indication is accurate to about ± 0.1 millitorr provided the instrument has been carefully zeroed at vacuum. See Section 4.5 on page 4-14 for vacuum and atmosphere calibration procedures. For accurate use in the 10^{-4} range, zeroing should be repeated frequently.

Pressure readings in the 10^{-4} Torr range may differ from those found from ion gauges, since ion gauges usually lose sensitivity near their upper pressure limits.

5.2 Operation of Micro-Ion Gauge Electrometer Module

5.2.1 Displaying Sensitivity with the Calibration Switch

This switch is used for displaying pressure or gauge sensitivity. It is activated by setting to the on position. The function depends on the state of the Micro-Ion Gauge tube:

If the tube is off, setting the switch ON displays the tube sensitivity in the display. This will be in scientific notation. If the tube is on, the switch has no effect and pressure will be displayed.

 **Do not leave the calibration switch set after you are done viewing sensitivity or emission; otherwise, the display reading may be mistaken for an actual pressure reading.**

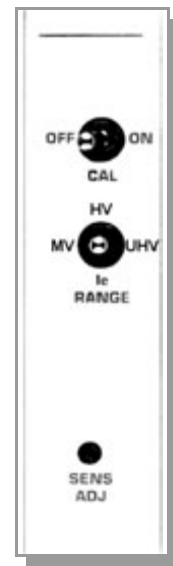

Figure 5-3 Electrometer Module Front Panel.

5.2.2 Emission Range Switch

This switch selects between three emission ranges; 20 microamperes (MV), 1 milliampere (HV), or 4 milliamperes (UHV).

In general, higher emissions are used at lower pressures. If you are measuring very low pressures the 4 mA range is best. Lower emissions will increase tube life.

The overpressure shutdown point will change inversely proportional to the emission range.

5.2.3 Sensitivity Adjustment

The Sensitivity Adjustment (see Figure 5-3) on the Electrometer module is used to match tubes of different sensitivities. The Calibration switch on the Electrometer module must be ON with the IG OFF to view sensitivity during the adjustment.

The 358 Controller is preset for a tube sensitivity of 20/Torr which is typical for the 355 tube. The approximate range of the adjustment is 3 to 50/Torr.

5.2.3.1 Relative Gas Sensitivities

Sensitivity depends on the gas being measured as well as the type of IG tube. Table 5-2 on page 5-5 lists the relative gauge sensitivities for common gases. These values are from NASA Technical Note TND 5285, "Ionization Gauge Sensitivities as Reported in the Literature", by Robert L. Summers, Lewis Research Center, National Aeronautics and Space Administration. Refer to this technical note for further definition of these average values and for the gauge sensitivities of other gases.

To adjust the 358 Controller to direct reading for gases other than air or N₂ during Micro-Ion Gauge operation, calculate the sensitivity K_x for gas type x as follows:

$$K_x = (R_x)(KN_2),$$

where KN₂ is the gauge sensitivity for N₂ and R_x is found from Table 5-2 on page 5-5.

Table 5-2 Relative Gas Sensitivities.

Gas	R _x	Gas	R _x
He	0.18	H ₂ O	1.12
Ne	0.30	NO	1.16
D ₂	0.35	Ar	1.29
H ₂	0.46	CO ₂	1.42
N ₂	1.00	Kr	1.94
Air	1.00	SF	2.50
O ₂	1.01	Xe	2.87

5.2.4 Filament Selection for the Micro-Ion Gauge Electrometer Module

5.2.4.1 Filament Select Switch

The Filament Select switch (see Figure 5-4) is used to operate each filament individually or both in series.

Normally only one filament should be selected.

During degas the BOTH position will clean up the tube more satisfactorily allowing for a lower ultimate pressure reading.

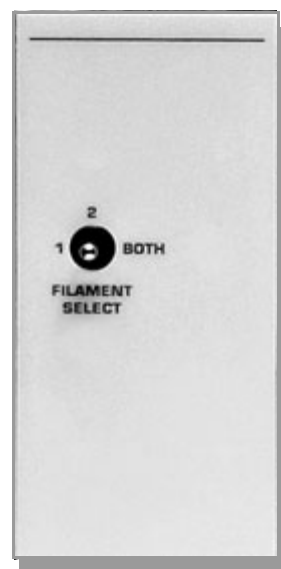

Figure 5-4 Micro-Ion Gauge Filament Select Switch.

5.3 Theory of Operation

5.3.1 Micro-Ion Gauge Theory of Operation

The functional parts of a typical ionization gauge are the filament (cathode), grid (anode) and ion collector, which are shown schematically in Figure 5-5. These electrodes are maintained by the gauge Controller at +30, +180, and 0 volts, relative to ground, respectively.

The filament is heated to such a temperature that electrons are emitted, and accelerated toward the grid by the potential difference between the grid and filament. Most of the electrons eventually collide with the grid, but many first traverse the region inside the grid one or more times.

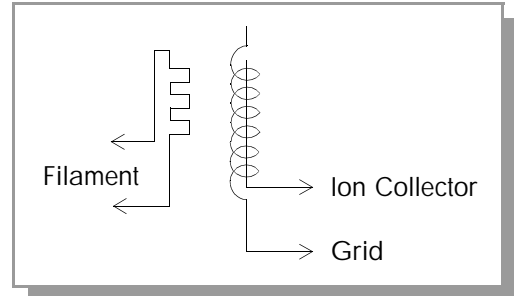

Figure 5-5 Micro-Ion Gauge Schematic.

When an energetic electron collides with a gas molecule an electron may be dislodged from the molecule leaving it with a positive charge. Most ions are then accelerated to the collector. The rate at which electron collisions with molecules occur is proportional to the density of gas molecules, and hence the ion current is proportional to the gas density (or pressure, at constant temperature).

The amount of ion current for a given emission current and pressure depends on the Micro-Ion Gauge design. This gives rise to the definition of Micro-Ion Gauge "sensitivity," frequently denoted by "K."

$$K = \frac{\text{ion current}}{\text{emission current} \times \text{pressure}}$$

The 355 type gauge has a sensitivity of 20/Torr when used with nitrogen or air. Sensitivities for other gases are given in Section 5.2.3.1 on page 5-4.

The Micro-Ion Gauge Controller varies the heating current to the filament to maintain a constant electron emission, and measures the ion current to the collector. The pressure is then calculated from these data.

5.3.2 Convector Gauge Theory of Operation

The Convector Gauge transducer is represented in Figure 5-6 as R1, R2, R3, and R4. These four resistances form the legs of a bridge circuit, with R1 designating the sensor wire of the transducer. R2 is a resistive network in the tube that compensates for changes in the ambient temperature. At bridge null, $R1 = R2 \times R3 / R4$. If there are no changes in ambient temperature, the value of R1 is a constant and the bridge is balanced.

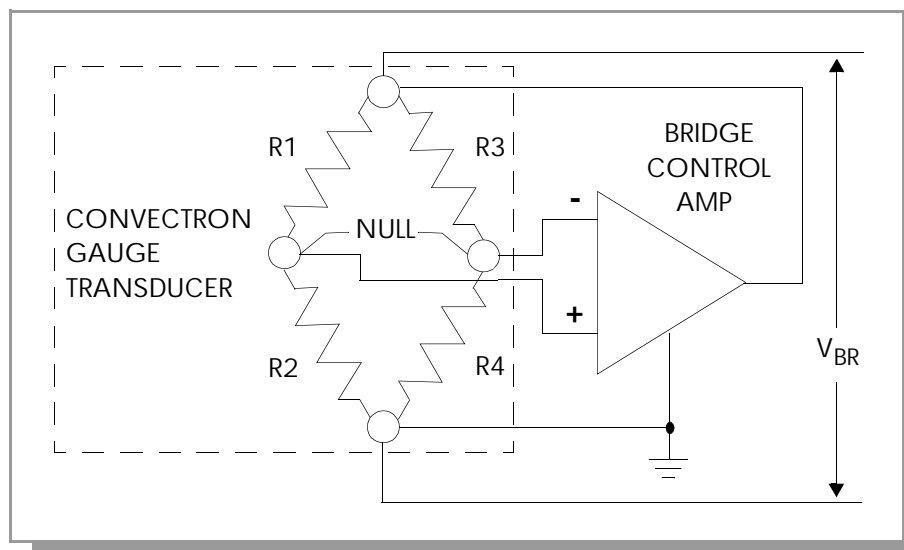

Figure 5-6 Simplified Schematic Convector Gauge Module.

As the vacuum system pressure is decreased, there are fewer molecules in the system to conduct the heat away from the sensor wire causing the temperature and resistance of R1 to increase. The increased resistance of R1 causes the bridge to unbalance and a voltage is developed across the null terminals. The bridge control circuit senses the null voltage and decreases the voltage across the bridge until the null voltage is again zero. When the bridge voltage is decreased, the power dissipated in the sensor wire is decreased causing the resistance of R1 to decrease to its previous value. The opposite events happen for a pressure increase. The bridge voltage is a non-linear function of pressure.

All materials have been chosen for ultra high vacuum service, corrosion resistance and bakeability to 150 °C. The gauge tube envelope is type 304 stainless steel. All metallic joints in the envelope are TIG welded. No solder is used within the envelope. The following materials are exposed to the vacuum. Type 304 stainless steel, Carpenter Alloy 52, Kovar[®], Kapton[®], gold plated tungsten, borosilicate glass and Dow-Corning 9015 glass. The blue trim cover is molded of Ultem[®] polyetherimide resin suitable for service to 150 °C.

5.3.3 Microcontrollers and Bus Structure

The Electrometer module in the 358 has a dedicated microcontroller with internal ROM, RAM, timing, and interrupt management functions. This architecture provides high-performance at low cost with greater reliability and noise immunity than more complicated microprocessor systems using external buses and memory hardware.

The microcontroller is equipped with a watchdog timer, which automatically generates a reset if the processor fails to fulfill timing “checkpoints” within its code. Inter-processor communication is accomplished via the display bus. These lines carry BCD-format pressure data that is used to generate the 358 display.

5.3.4 Process Control Theory of Operation

The Process Control module contains a dedicated microcontroller and a non-volatile memory chip for storage of the setpoints. This chip has a rated life of 10,000 erase/write cycles for each setpoint, and will retain data for 10 years. Since data is read/written to this chip serially, it is necessary to store working copies of the setpoints in internal RAM memory.

The microcontroller compares the setpoints with the pressure display data on the display bus and makes a decision as to whether or not to activate a channel's relay.

The manual override switches, when thrown in one direction or the other, take precedence over the microcontroller's decision.

5.3.4.1 Process Control Specifications

Table 5-3 Process Control Specifications.

Item	Specification
Number of channels	1 — 6
Pressure range	1.0×10^{-12} to $9.9 \times 10^{+5}$
Hysteresis	10%
Setpoint adjustment	Digital, 2 significant digits plus exponent
Output relays	
Contact rating	5A @ 120 Vac, 4A @ 240 Vac resistive or 5A @ 30 Vdc.
Contact style	SPDT

Service and Maintenance

6.1 Service Guidelines

Some minor difficulties are readily corrected in the field. Each module has fault indicator LEDs which help localize failures.

If a Qualified Service Person makes repairs at the component level, repairs properly made with equivalent electronic parts and rosin core solder do not void the warranty.

Because the 358 Controller contains static-sensitive electronic parts, the following precautions must be followed when troubleshooting:

- Use a grounded, conductive work surface. Wear a high impedance ground strap for personnel protection.
- Use conductive or static dissipative envelopes to store or ship static sensitive devices or printed circuit boards.
- Do not operate the product with static sensitive devices or other components removed from the product.
- Do not handle static sensitive devices more than absolutely necessary, and only when wearing a ground strap.
- Do not use an ohmmeter for troubleshooting MOS circuits. Rely on voltage measurements.
- Use a grounded, electrostatic discharge safe soldering iron.

NOTE: This product has been designed and tested to offer reasonably safe service provided it is installed, operated, and serviced in strict accordance with these safety instructions.



The service and repair information in this manual is for the use of Qualified Service Personnel. To avoid shock, do not perform any procedures in this manual or perform any servicing on this product unless you are qualified to do so.



Do not substitute parts or modify instrument.

Because of the danger of introducing additional hazards, do not install substitute parts or perform any unauthorized modification to the product. Return the product to a service facility designated by Helix Technology for service and repair to ensure that safety features are maintained. Do not use this product if it has unauthorized modifications.

6.2 Damage Requiring Service

Disconnect this product from the wall outlet and any other power sources, and refer servicing to Qualified Service Personnel if any the following conditions exist:

- The gauge cable or plug is damaged.
- Liquid has been spilled onto, or objects have fallen into, the product.
- The product has been exposed to rain or water.
- The product does not operate normally even if you have followed the Operation Instructions. Adjust only those controls that are covered in the instruction manual. Improper adjustment of other controls may result in damage and require extensive work by a qualified technician to restore the product to its normal operation.
- The product has been dropped or the enclosure has been damaged.
- The product exhibits a distinct change in performance. This may indicate a need for service.



Replacement Parts - When replacement parts are required, be certain to use the replacement parts that are specified by Helix Technology, or that have the same characteristics as the original parts. Unauthorized substitutions may result in fire, electric shock or other hazards.



Safety Check - Upon completion of any service or repairs to this product, ask the Qualified Service Person to perform safety checks to determine that the product is in safe operating order.



Finite Lifetime - After ten years of normal use or even non-use, the electrical insulation in this product may become less effective at preventing electrical shock. Under certain environmental conditions which are beyond the manufacturer's control, some insulation material may deteriorate sooner. Therefore, periodically inspect all electrical insulation for cracks, crazing, or other signs of deterioration. Do not use if the electrical insulation has become unsafe.

Table 6-1 General Symptoms/Possible Causes.

Symptom	Possible Cause
Unit will not power-up, no response to power switch.	Power fuse blown. Wrong line voltage selection, see Section 3.2.4 on page 3-4.
Power fuse blows repeatedly.	Wrong fuse rating. Wrong line voltage selection, see Section 3.2.4 on page 3-4.
Fault relay tripped.	Unplugged Convectron Gauge or sensor broken in Convectron Gauge. Convectron Gauge zero badly out of calibration. Microprocessor reset occurring on a module (probable circuit failure). Checksum failure on process control board. (See Section 6.5 on page 6-6.) Cycle power and check all setpoints.

Symptom	Possible Cause
IG will not turn on, or turns on briefly then shuts off.	IG at too high pressure. Auto turn off circuit in Convector Gauge module is shutting off IG. Emission current setting wrong for pressure in gauge. Improper IG connector hookup. Badly contaminated IG. Damaged or contaminated cathode coating, will not sustain emission. Short in IG cable. Short between IG electrodes. Open cathode in IG.
IG display shows a steady number when IG is off.	Scale factor switch is not in its center position.
Convector Gauge display reads a fixed (non changing) pressure.	IG AUTO switch is left in the SET position.
Pressure reading is higher than expected.	IG contaminated. Low (L) pressure range is not selected appropriately (pressure is below 10^{-7} Torr). Interference from other ion source. Poor conductance in gauge's vacuum connection to chamber. Gas source in plumbing to gauge, such as leak or contamination. Chamber pressure high because of leak, contamination, or pump failure. Poor location selected for gauge. Faulty gauge or power cable. Faulty electrometer.
Degas will not turn on.	System pressure above 5×10^{-5} Torr. IG not turned on.
IG shuts off when degas is initiated.	Degas fuse blown. Badly contaminated IG.
IG pressure reads extremely low.	Collector unplugged. Bad collector cable. Faulty electrometer.
IG pressure readout very erratic.	IG badly contaminated. Improper IG or Controller grounding. Bad collector cable. Excessive noise source. Interference from other charged particle source in chamber. Faulty electrometer.
Green +18 LED out on control board.	+18 volt supply to relays faulty.
Green +15 LED out.	+15 volt supply faulty (power to analog circuitry and RS-232).
Green -15 LED out.	-15 volt supply faulty (power to analog circuitry and RS-232).
Green +5 display LED out.	+5 volt supply to display LED's faulty.
Green +5 logic LED out.	+5 volt logic supply faulty.

6.3 Overpressure Shutdown

As pressure increases, the ion current to the collector increases until the high density of gas molecules begins to interfere with the ionization process. When some electrons cannot acquire sufficient energy to ionize the gas molecules, the collector current no longer increases with increasing pressure. This pressure is called the “turn around” pressure. Further pressure increases will result in a decreasing ion current.

The Controller is factory set so the ion gauge will shut down when the pressure rises above the overpressure setpoint pressures shown in Table 6-2.

For reliable operation in general applications, the overpressure shutdown point is factory set below the Micro-Ion Gauge turn around point at both emission currents. **Although we strongly recommend that you do not change the factory settings**, the overpressure shutdown can be readjusted for specific applications according to the following procedure.



Caution: If the overpressure shutdown point is increased from the factory settings, an excess pressure rise may go undetected—resulting in possible gauge and/or vacuum system damage. Consult factory if in doubt.

Table 6-2 Overpressure Shutdown Factory Settings.

Pressure Range	Overpressure Point (Torr)
H	2×10^{-2}
L	5×10^{-4}

To adjust the overpressure shutdown point on the Electrometer Module to a different level:

1. Rotate the overpressure adjustment potentiometer clockwise several turns until the overrun clutch clicks.
2. Turn on the ion gauge.
3. Maintain system pressure at the desired shutdown point.
4. Rotate the adjustment potentiometer counter-clockwise slowly until the IG turns off.

6.4 Troubleshooting the Convectron Gauge Module

Table 6-3 Convectron Gauge Module Troubleshooting.

Symptom	Possible Cause
Pressure reading grossly in error.	Controller out of calibration. Unknown gas type. Gauge not mounted horizontally (see Section 3.3 on page 3-5). Sensor damaged (e.g., by reactive gas). Gauge very dirty. Extremes of temperature or mechanical vibration.
CGA over current indicator lit.	Cable short, pins 1-3.
CGB over current indicator lit.	Cable short, pins 1-3.
Bridge circuit indicators lit.	Circuit failure.
CGA unplugged indicator lit.	CGA unplugged; open sensor wire.
CGB unplugged indicator lit.	CGB unplugged; open sensor wire.
Microprocessor reset LED lit or flashing.	Microprocessor failure.
A/D integration failure indicator lit or flashing.	Circuit failure.
Display reads blank.	Gauge unplugged; open sensor wire.

6.4.1 Convectron Gauge Test Procedure

The small diameter sensor wire can be damaged by small voltages. Do not perform electrical continuity tests with instruments applying in excess of 1 volt when the gauge is at vacuum, or 5 volts when at atmospheric pressure.

The Convectron Gauge should show the following resistances (pin numbers are embossed on the gauge base):

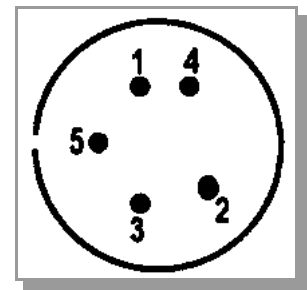

Table 6-4 Convectron Gauge Resistances.

Pressure Range	Overpressure Point (Torr)
Pins 1 to 2	20 to 25 ohms
Pins 2 to 3	50 to 60 ohms
Pins 1 to 5	175 to 190 ohms

Figure 6-1 Convectron Gauge Base.

If the resistance from pin 1 to pin 2 is about 800 ohms, the sensor wire is open.

6.4.2 Cleaning Contaminated Convector Gauges



The fumes from solvents such as trichloroethylene, perchlorethylene, toluene, and acetone can be dangerous to health if inhaled. If used, use only in well-ventilated area exhausted to the outdoors. Acetone and toluene are highly flammable and should not be used near an open flame or energized electrical equipment.

The Convector Gauge may be baked to 150 °C nonoperating while under vacuum with the Connector removed.

All materials have been chosen for ultra high vacuum service, corrosion resistance and bakeability. The envelope is type 304 stainless steel. All metallic joints in the envelope are TIG welded. No solder is used within the envelope. The following materials are exposed to the vacuum: Type 304 stainless steel, Carpenter Alloy 52, Kovar, Kapton, gold plated tungsten, borosilicate glass and Dow-Corning 9015 glass. The blue trim cover is rated at 150 ° C.

When the small sensor wire is contaminated with oil or other films, its emissivity or its diameter may be appreciably altered and a change of calibration will result. Cleaning with trichloroethylene, perchloroethylene, toluene, or acetone is possible but it must be done very carefully so as not to damage the sensor.

Hold the gauge with the main body horizontal and the port projecting upward at an angle of 45°. Slowly fill it with solvent using a standard wash bottle with the spout inserted in the port to where it touches the screen. Let the solvent stand in the gauge for at least ten minutes. **Do not shake the gauge.** Shaking the gauge with liquid inside can damage the sensor wire. To drain the gauge, position it horizontally with the port facing downward. Slightly warming the gauge will help dry the gauge. Then allow the gauge to dry overnight with the port vertically downward and uncapped. Before reinstalling the gauge on the system, be certain no solvent odor remains.

6.5 Process Control Troubleshooting

If the μ P FAILURE LED is lit or flashing, there is a probable circuit failure. Return this product to a service facility designated by Helix Technology for repair.

The setpoints are read from non-volatile memory into RAM when the unit powers up. On power up, a checksum is computed and stored in RAM, and is updated whenever a setpoint is changed. It is then periodically re-computed from the existing setpoints and checked against the pre-existing value. If for any reason (such as a power fluctuation or electrical transient in the system) a setpoint becomes corrupted, this method will trap the error. If this occurs the fault relay will be released if the Remote Input/Output Module is installed and will remain released until power is cycled on the Controller.

If a setpoint is found to contain garbled data which cannot be interpreted as a valid setpoint, it will be set to 0, and the fault relay, if present, released.

6.6 RS-232 Troubleshooting

Because the RS-232 “standard” is found in a bewildering array of configurations, the first thing to do if trouble arises is check the following configuration options:

1. Check switch settings.

Be sure baud rate, character format and framing, and interface protocol are matched to your host computer or terminal's requirements. Note that there may be several mismatched parameters. Check to see if your computer requires the reversed-polarity RTS convention.

2. Check interface wiring.

The pin designations for the RS-232 connector are shown in Table 2-6 on page 2-10. Note that the “received” and “transmitted” data lines are defined as seen by the 358. Many companies supply “null modems” or switch boxes for the purpose of reconfiguring the control lines for particular applications.

3. Check command format.

Be sure the strings you output to the 358 are in accord with the syntax defined in Section 4.8.1 on page 4-17.

Table 6-5 RS-232 Troubleshooting Guide.

Symptom	Possible Cause
Microcontroller reset LED lit or flashing. (See Figure 2-16 on page 2-12.)	Microcontroller failure.
No response or garbled output.	Baud rate incorrect. Character length incorrect or stop bit(s) incorrect. Bad cable.
OVERRUN ERROR message.	Stop bit(s) incorrect, host software failure.
PARITY ERROR message.	Parity incorrect.
SYNTAX ERROR message.	Message to 358 not in accord with specified syntax. Could also result from failure to assert DCD handshake line.

6.7 RS-485 Troubleshooting

The first thing to do if trouble arises is check the following configuration options:

1. Check switching settings.

Be sure baud rate, character format and framing, and interface protocol are matched to your host computer or terminal's requirements. Note that there may be several mismatched parameters.

2. Check command format.

Be sure the strings you output to the 358 are in accord with the syntax defined in Section 4.9.1 on page 4-20.

Table 6-6 RS-485 Troubleshooting Guide.

Symptom	Possible Cause
Microcontroller reset LED CR1 lit or flashing.	Microcontroller failure.
No response or garbled output.	Baud rate incorrect. Character length incorrect or stop bit(s) incorrect. Bad cable.
Will not respond intermittently.	Poor cable connections, ground fluctuations (the maximum common mode potential across the system is 7V) and EMI from other sources. If the start character is not received properly, the 358 may not interpret it as a start character and the 358 will not respond. Host software must be prepared to re-send a command if a response is not generated within a reasonable period of time.
OVERRUN ERROR message.	Stop bit(s) incorrect, host software failure.
PARITY ERROR message.	Parity incorrect.
SYNTAX ERROR message.	Message to 358 not in accord with specified syntax.

6.8 Field Installation of Modules

1. **Turn off power.**
2. **With power off, remove any cables from the Controller rear panel.**
3. Observe antistatic precautions to avoid damaging static sensitive components inside the chassis. Use a grounded, conductive work surface. Do not handle MOS devices more than absolutely necessary, and only when wearing a high impedance ground strap. Use conductive envelopes to store or ship MOS devices or printed circuit boards. Do not operate the Controller with MOS devices removed from the printed circuit boards.
4. See Section 2.1.1 on page 2-1 for how to remove the top cover.
5. Locate correct position for module.
6. Carefully remove the bus ribbon cable from all modules located to the right (as you face the front panel) of the position where the module is to be installed. Remove connectors slowly using pull tabs.
7. Lift out the filler module at the position where the module is to be installed.
8. Install the module in its proper position making sure all ends lock together.
9. Carefully reconnect the bus ribbon connectors.
10. Select appropriate switch settings. See Chapter 2.
11. Replace the top cover as directed in Section 2.6 on page 2-17.

6.9 Service Form

Please photocopy this form, fill it out, and return it with your equipment:

RA No. _____ Contact Helix Technology Customer Service at **1-303-652-4400**,
or **1-800-776-6543 in the USA**; FAX: **1-303-652-2844**, or
email: **salesco@helixtechnology.com**

Model No. _____ Serial No. _____ Date _____

Name _____ Phone No. _____

Company _____

Address _____

City _____ State _____ Zip _____

Please help Helix Technology continue to provide the best possible service by furnishing information that will help us determine the cause of the problem, as well as protect our analysis and calibration equipment from contamination.

Problem description: _____

Application description: _____

Has this product been used with high vapor pressure or hazardous materials? Yes No

If Yes, please list the types of gas, chemicals (common names, specific chemical,) biological materials, or other potentially contaminating or harmful materials exposed to the product during its use.

NOTE: PRODUCTS EXPOSED TO RADIOACTIVE MATERIAL CANNOT BE ACCEPTED BY HELIX TECHNOLOGY UNDER ANY CIRCUMSTANCES.

Signature: _____

Printed Name _____ Phone No. _____

A

- Address, RS-485 **2-15**
- Analog output
 - Connecting **3-9**
 - Convectron Gauge
 - Connecting **3-10**
 - Convectron Gauge signal **3-10**
 - Electrometer module signal **3-9**
 - Micro-Ion Gauge
 - Signal **4-2**
- Analog output connector
 - Convectron Gauge, Illustration **1-5**
 - Micro-Ion Gauge, Illustration **1-5**
- Analog output signal
 - Convectron Gauge **4-15**
 - Micro-Ion Gauge **4-2**

B

- Baud rate
 - RS-232 **2-10**
 - RS-485 **2-16**
- BCD-format pressure data **5-7**
- Blinking DEGAS LED **5-2**
- Bus structure **5-7**
- Byte format
 - RS-232 **2-10**
 - RS-485 **2-16**

C

- Cable installation statement **3-1**
- Calibration switch, Electrometer module **5-4**
- Certification, product **ix**
- Channel
 - Gauge assignment, Process Control **2-7**
 - Identification windows, Process Control **2-5**
 - Override switches **3-11**
- Character framing
 - RS-232 **2-11**
 - RS-485 **2-16**
- Collector connector for Micro-Ion Gauge **1-5**
- Commands
 - RS-232 **4-17**
 - RS-485 **4-20**

Connectors

- Analog output, Convectron Gauge, Illustration **1-5**
- Analog output, Micro-Ion Gauge, Illustration **1-5**
- Convectron Gauge cable, Illustration **1-5**
- DB25S for RS-232 **2-10**
 - Illustration **1-5**
- DE9 connector **1-5**
- J1, J2 **1-6**
- Micro-Ion Gauge
 - Collector connector **1-5**
- Power input, Illustration **1-5**
- Process Control pinouts **3-11**
- Process Control, Illustration **1-5**
- Remote input/output, Illustration **1-7**
- RS-232, Illustration **1-6**
- RS-232, pinouts **2-10**
- RS-485, Illustration **1-6**
- RS-485, pinouts **2-14**
- Control logic, Process Control **2-5**
- Controller
 - Dimensions **1-10**
 - Front panel **1-2**
 - Front panel, door open **1-3**
 - Front panel, Illustration **2-5**
 - Ground test procedure **3-7, 3-8**
 - Grounding **3-7**
 - Installation **3-2**
 - Line voltage **3-4**
 - Mounting configurations **3-3**
 - Options **1-9**
 - Rear Panel with On/Off switch **4-1, 5-1**
 - Rear panel with RS-232 option **1-5, 1-6**
 - Rear Panel with RS-485 option **1-6, 3-12, 3-13**
 - Removing top cover **2-1**
 - Replacing top cover **2-17**
 - Setup **2-1**
 - Specifications **1-8**
 - Top view, cover removed **1-4**
 - Turning on **4-1, 5-1**
- Convectron Gauge
 - Analog output - connecting **3-10**
 - Analog output signal **3-10, 4-15**
 - cable connector, Illustration **1-5**

Cleaning **6-6**

- Dimensions **1-11**
- Display formats **5-2**
- Fittings **1-11**
- Gases other than nitrogen or air **4-4**
 - Illustration **1-1**
- Installation **3-5**
- Module, top view **1-4, 2-4**
- Mounting **3-5**
- Mounting options **3-6**
- Operation **5-2, 5-3**
- Operation, preparing for **4-3**
- Pressure display **5-1**
- Pressure relief valves and disks **4-3**
- Pressure units setup **2-4**
- Specifications **1-10**
- Test procedure **6-5**
- Theory of Operation **5-7**
- Troubleshooting **6-5**
- Turning on, alternate **4-2**
- Use below 10^{-3} Torr **5-3**
- Vacuum connections **3-6**
- Zero and atmospheric indications **4-14**
- Convectron module, display update rate **2-4**

D

- Damage requiring service **6-2**
 - safety **vi**
- Data timing
 - RS-485 **2-15**
- DB25S connector **2-10**
 - Illustration **1-5**
- DE9 connector
 - Illustration **1-5**
- Degas, On/Off **5-3**
- Dimensions
 - Controller **1-10**
 - Convectron Gauge **1-11**
 - Micro-Ion Gauge **1-11**
- Display
 - Formats, Convectron Gauge **5-2**
 - Update rate, Convectron module **2-4**
 - Update rate, Electrometer module **2-3**

E

- Electrometer module
 - Analog output signal **3-9**
 - Calibration switch **5-4**
 - Display update rate **2-3**
 - Emission Range switch **5-4**
 - Pressure units setup **2-2**
 - Sensitivity Adjustment **5-4**
 - top view **1-4, 2-2**
- EMC compliance **3-1**
- Emission Range switch, Electrometer module **5-4**
- Environmental conditions **3-2**
- Error messages
 - RS-232 **4-19**
 - RS-485 **4-21**

F

- FCC verification **ix**
- Field installation of modules **6-9**
- Filament Select switch **5-5**
- Fittings **1-11**
- Front panel
 - Channel identification windows **2-5**
 - Illustration **1-2**
- Fuse
 - Replacement **3-4**
 - Type **3-4**

G

- Gases other than nitrogen or air **4-4**
- Ground connections **3-7**
- Grounding
 - Illustration **3-8**
 - Lug, Illustration **1-5**
 - System **3-7**
 - System ground test procedure **3-7, 3-8**

H

- Handshake, RS-232 **2-12**

I

- IG Process Control channel switch settings **2-7**
- Illustrations
 - Changing units of measure label **2-2**
 - Controller
 - Front panel **1-2, 2-5**
 - Front panel, door open **1-3**
 - On/Off switch **4-1, 5-1**

- Rear panel with RS-232 option **1-5, 1-6**
- Rear panel with RS-485 option **1-6, 3-12, 3-13**
- Top view, cover removed **1-4**

- Convectron Gauge **1-1**
- Convectron Gauge module **1-4, 2-4**

- Correct System Grounding **3-8**
- DB25 connector for RS-232 computer interface **1-5**

- DE9 connector **1-5**
- Electrometer module **1-4, 2-2**

- Fittings **1-11**
- Front panel, channel identification windows **2-5**

- Ionization gauge module **1-4**

- Micro-Ion Gauge **1-1**
- Rear panel **1-5**

- Mounting
 - Controller **3-3**
 - Convectron Gauge **3-5**
- One to four channel Process Control **2-6**

- Power supply module **1-4**
- Process Control
 - Channel override switches **3-11**

- Module **1-4**
- RS-232 module **1-4**
- Six channel Process Control **2-6**

- Installation **3-1**
- Cable installation statement **3-1**
- Connecting RS-232 **3-12**
- Connecting RS-485 **3-13**
- Controller **3-2**
- Controller mounting configurations **3-3**
- Convectron Gauge **3-5**
- Field, of modules **6-9**
- Grounding the system **3-7**
- Hardware part numbers **3-2**
- Mounting controller **3-3**
- System ground test procedure **3-7, 3-8**

- Tips **3-1**
- Invert RTS, RS-232 **2-13**
- Ionization gauge module, top view **1-4**

- Tips **3-1**
- Invert RTS, RS-232 **2-13**
- Ionization gauge module, top view **1-4**

J

- J1, J2 connectors **1-6**

L

- LED, DEGAS, blinking **5-2**
- Line voltage, Controller **3-4**
- Logic diagram, Process Control **2-5**

M

- Microcontrollers **5-7**
- Micro-Ion Gauge
 - Alternate on/off **4-2**
 - Analog output signal **4-2**
 - Collector connector, Illustration **1-5**

- Degas On/Off switch **5-3**
- Dimensions **1-11**
- Fittings **1-11**
- Illustration **1-1**
- Operation **4-1, 5-4**
- Pressure display **5-1**
- Pressure indication **4-2**
- Pressure measurement **4-1**
- Rear panel, Illustration **1-5**
- Specifications **1-9**
- Theory of Operation **5-6**
- Turning on, alternate **4-2**
- Turning on/off **5-3**

- Micro-Ion Gauge
 - Operation **5-2**

- Mounting
 - Convectron Gauge **3-5**
 - options **3-6**

O

- Operation **5-1**
- Convectron Gauge **5-2**
 - Preparing for **4-3**
 - Theory of **5-7**
- Micro-Ion Gauge **4-1, 5-2, 5-4**
 - Theory of **5-6**
- Preparing for **4-1**
- Process Control, preparing for **4-16**
- Process Control, theory of **5-8**
- RS-232 commands **4-17**
- RS-232, preparing for **4-17**
- RS-485 commands **4-20**
- RS-485, preparing for **4-19**
- Turning on
 - Gauges, alternate **4-2**
 - Micro-Ion Gauge **5-3**
 - System **4-1, 5-1**
- Overpressure shutdown adjustment **2-3**

P

- Part numbers
 - Fuse **3-4**
 - Installation hardware **3-2**
- Pinouts
 - Process Control connector **3-11**
 - RS-232 **2-10**
 - RS-485 **2-14**
- Power input connector, Illustration **1-5**
- Power supply Module, top view **1-4**
- Power switch, Illustration **1-5**
- Preparing for operation **4-1**
- Pressure
 - Display
 - Convectron Gauge **5-1**
 - Micro-Ion Gauge **5-1**
 - Indication, Micro-Ion Gauge **4-2**
 - Measurement **4-1**
 - Overpressure shutdown **6-4**
 - Relief valves and disks,
 - Convectron Gauge **4-3**
 - Turn around **6-4**
 - Units setup **2-2**
 - Units, display formats **5-2**
- Process Control
 - Channel assignment **2-7**
 - Channel identification windows **2-5**
 - Channel override switches **3-11**
 - Connecting relays **3-11**
 - Connector, Illustration **1-5**
 - Gauge assignment **2-7**
 - Logic diagram **2-5**
 - Module, top view **1-4**
 - Operation, preparing for **4-16**
 - Output connector pin assignments **3-11**
 - Relay ratings **2-3, 2-5**
 - Setpoint display **4-16**
 - Setpoint display and adjustment **4-16**
 - Setpoint manual override **4-16**
 - Setpoint, modifying **4-17**
 - Setup **2-4**
 - Specifications **5-8**
 - Theory of Operation **5-8**
 - Tips **2-9**
 - Troubleshooting **6-6**
- R**
 - Relay
 - Polarity setting **2-8**
 - Ratings **2-3, 2-5**
 - Relays, connecting Process Control **3-11**
 - Remote input/output connector

- Illustration **1-7**
- Pin functions **1-7**
- Response delay, RS-485 **2-16**
- RS-232
 - Baud rate **2-10**
 - Byte format **2-10**
 - Character framing **2-11**
 - Command Summary **3-12**
 - Command syntax **4-17**
 - Connecting **3-12**
 - Connector **1-6**
 - Error messages **4-19**
 - Handshake **2-12**
 - Interface setup **2-9**
 - Invert RTS **2-13**
 - Module, top view **1-4**
 - Operation, preparing for **4-17**
 - Reversing the Polarity of RTS **3-12**
 - Specifications **1-6**
 - Talk-only mode **2-11**
 - Troubleshooting **6-7**
- RS-485
 - Address **2-15**
 - Baud rate **2-16**
 - Byte format **2-16**
 - Character framing **2-16**
 - Command syntax **4-20**
 - Connecting **3-13**
 - Connectors **1-6**
 - Data timing **2-15**
 - Error messages **4-21**
 - Interface setup **2-14**
 - Operation, preparing for **4-19**
 - Response delay **2-16**
 - Specifications **1-6**
 - Troubleshooting **6-8**
- S**
 - Safety
 - Damage requiring service **vi**
 - instructions **v**
 - Sensitivity Adjustment, Electrometer module **5-4**
 - Service
 - Damage requiring **6-2**
 - Symptoms/Causes **6-2**
 - Form **6-10**
 - Guidelines **ix, 6-1**
 - Setpoint
 - Display, Process Control **4-16**
 - Manual Override **4-16**
 - Modifying, Process Control **4-17**
 - Setup
 - Controller **2-1**
 - Initial procedures **2-1**
 - Pressure units **2-2**
 - Process Control **2-4**
 - RS-232 **2-9**
 - RS-485 **2-14**
 - Shutdown, overpressure **6-4**
 - Slow Update switch
 - Convectron module **2-4**
 - Electrometer module **2-3**
 - Specifications **1-8**
 - Process Control **5-8**
 - RS-232 **1-6**
 - RS-485 **1-6**
 - Switches
 - Calibration, Electrometer module **5-4**
 - Channel Override, Process Control **3-11**
 - Emission Range, Electrometer module **5-4**
 - Filament Select **5-5**
- T**
 - Talk-only mode, RS-232 **2-11**
 - Theory of operation
 - Convectron Gauge **5-7**
 - Micro-Ion Gauge **5-6**
 - Process Control **5-8**
 - Tips
 - Gauge installation **3-1**
 - Process Control **2-9**
 - Top cover
 - Removing **2-1**
 - Replacing **2-17**
 - Troubleshooting
 - Convectron Gauge module **6-5**
 - Process Control module **6-6**
 - RS-232 **6-7**
 - RS-485 **6-8**
- U**
 - Units of measure
 - Changing label **2-2**
 - Label on front panel **2-1**
 - Setup **2-2**
- V**
 - Vacuum connections **3-6**
- W**
 - Warranty **ix**
- Z**
 - Zero and atmospheric indications,
 - Convectron Gauge **4-14**

